

Appendix AI ADMINISTRATIVE INSTRUCTIONS UNDER THE PCT

(as in force from February 12, 2004)

TABLE OF CONTENTS¹

	TABLE OF CONTENTS		
		Section 207	Arrangement of Elements and Numbering of Sheets of the International Application
Part 1:	Instructions Relating to General Matters	Section 208	Sequence Listings
		Section 209	Indications as to Deposited Biological Material on a Separate Sheet
Section 101	Abbreviated Expressions and Interpretation	Section 210	Calculation of Designation Fee for the Purposes of National and Regional Patents
Section 102	Use of the Forms	Section 211	Declaration as to the Identity of the Inventor
Section 102 ^{bis}	Filing of Request in PCT-EASY Format Together with PCT-EASY Diskette Containing Request Data and Abstract	Section 212	Declaration as to the Applicant's Entitlement to Apply for and Be Granted a Patent
Section 103	Languages of the Forms Used by International Authorities	Section 213	Declaration as to the Applicant's Entitlement to Claim Priority of Earlier Application
Section 104	Language of Correspondence in Cases Not Covered by Rule 92.2	Section 214	Declaration of Inventorship
Section 105	Identification of International Application with Two or More Applicants	Section 215	Declaration as to Non-Prejudicial Disclosures or Exceptions to Lack of Novelty
Section 106	Change of Common Representative	Section 216	Notice of Correction or Addition of a Declaration Under Rule 26 ^{ter}
Section 107	Identification of International Authorities and of Designated and Elected Offices		
Section 108	Correspondence Intended for the Applicant		
Section 109	File Reference		
Section 110	Dates	Part 3:	Instructions Relating to the Receiving Office
Section 111	[Deleted]		
Section 112	Ceasing of Effect under Articles 24(1)(iii) and 39(2), Review under Article 25 (2) and Maintaining of Effect under Articles 24(2) and 39(3)	Section 301	Notification of Receipt of Purported International Application
Section 113	Special Fees Payable to the International Bureau	Section 302	Priority Claim Considered Not To Have Been Made
Section 114	[Deleted]	Section 303	Deletion of Additional Matter in the Request
Section 115	Indications of States, Territories, and Intergovernmental Organizations	Section 304	Invitation to Pay Fees Before Date on Which They Are Due
		Section 305	Identifying the Copies of the International Application
Part 2:	Instructions Relating to the International Application	Section 305 ^{bis}	Preparation, Identification and Transmittal of the Copies of the Translation of the International Application
Section 201	Language of the International Application	Section 306	Delayed Transmittal of Search Copy
Section 202	[Deleted]	Section 307	System of Numbering International Applications
Section 203	Different Applicants for Different Designated States	Section 308	Marking of the Sheets of the International Application and of the Translation Thereof
Section 204	Headings of the Parts of the Description	Section 309	Procedure in the Case of Later Submitted Sheets
Section 205	Numbering and Identification of Claims Upon Amendment		
Section 206	Unity of Invention		

¹ Table of Contents added for the convenience of the reader; it is not part of the Administrative Instructions.

MANUAL OF PATENT EXAMINING PROCEDURE

Section 310	Procedure in the Case of Missing Drawings	Section 331	Receipt of Confirmation Copy
Section 311	Renumbering in the Case of Deletion, Substitution or Addition of Sheets of the International Application and of the Translation Thereof	Section 332	Notification of Languages Accepted by the receiving Office under Rules 12.1(a) and (c) and 12.4(a)
Section 312	Notification of Decision Not To Issue Declaration that the International Application Is Considered Withdrawn	Section 333	Transmittal of International Application to the International Bureau as Receiving Office
Section 313	Documents Filed with the International Application; Manner of Marking the Necessary Annotations in the Check List	Section 334	Notification to Applicant of Submission of Demand After the Expiration of 19 Months from the Priority Date
Section 314	Correction or Addition of a Priority Claim under Rule 26 ^{bis}	Section 335	Transmittal of PCT-EASY Diskette Containing Request Data and Abstract
Section 315	Notification Concerning Confirmation of Designation	Section 336	Waivers Under Rules 90.4(d) and 90.5(c)
Section 316	Procedure in the Case Where the International Application Lacks the Prescribed Signature	Part 4:	Instructions Relating to the International Bureau
Section 317	Transmittal of a Notice of Correction or Addition of a Declaration Under Rule 26 ^{ter} .1	Section 401	Marking of the Sheets of the Record Copy
Section 318	Cancellation of Designations of Non-Contracting States	Section 402	Correction or Addition of a Priority Claim Under Rule 26 ^{bis}
Section 319	[Deleted]	Section 403	Transmittal of Protest Against Payment of Additional Fee and Decision Thereon Where International Application Is Considered To Lack Unity of Invention
Section 320	Invitation to Pay Fees under Rule 16 ^{bis} .1(a)	Section 404	International Publication Number of International Application
Section 321	Application of Moneys Received by the Receiving Office in Certain Cases	Section 405	Publication of Notifications of Languages Accepted by the receiving Office under Rules 12.1(a) and (c) and 12.4(a)
Section 322	Invitation to Submit a Request for Refund of the Search Fee	Section 406	Pamphlets
Section 323	Transmittal of Priority Documents to International Bureau	Section 407	The Gazette
Section 324	Copy of Notification of the International Application Number and the International Filing Date under Rule 20.5 (c)	Section 408	Priority Application Number
Section 325	Corrections of Defects Under Rule 26.4, Rectifications of Obvious Errors Under Rule 91.1, and Corrections Under Rule 9.2	Section 409	Priority Claim Considered Not To Have Been Made
Section 326	Withdrawal by Applicant Under Rule 90 ^{bis} .1, 90 ^{bis} .2, or 90 ^{bis} .3	Section 410	Numbering of Sheets for the Purposes of International Publication; Procedure in Case of Missing Sheets or Drawings
Section 327	<i>Ex Officio</i> Correction of Request by the Receiving Office	Section 411	Receipt of Priority Document
Section 328	Notifications Concerning Representation	Section 412	Notification of Lack of Transmittal of Search Copy
Section 329	Correction of Indications Concerning the Applicant's Residence or Nationality	Section 413	Corrections of Defects under Rule 26.4, Rectifications of Obvious Errors under Rule 91.1, and Corrections under Rule 9.2
Section 330	Transmittal of Record Copy Prevented or Delayed by National Security Prescriptions	Section 414	Notification to the International Preliminary Examining Authority Where the International Application is Considered Withdrawn
		Section 415	Notification of Withdrawal under Rule 90 ^{bis} .1, 90 ^{bis} .2, 90 ^{bis} .3 or 90 ^{bis} .4
		Section 416	Correction of Request in Record Copy

ADMINISTRATIVE INSTRUCTIONS UNDER THE PCT

Section 417	Processing of Amendments under Article 19	Section 504	Searching Authority Classification of the Subject Matter of the International Application
Section 418	Notifications to Elected Offices Where the Demand Is Considered Not To Have Been Submitted or Made	Section 505	Indication of Citations of Particular Relevance in the International Search Report
Section 419	Processing of a Declaration Under Rule 26 ^{ter}	Section 506	[Deleted]
Section 420	Copy of International Application and International Search Report for the International Preliminary Examining Authority	Section 507	Manner of Indicating Certain Special Categories of Documents Cited in the International Search Report
Section 421	Invitation To Furnish a Copy of the Priority Document	Section 508	Manner of Indicating the Claims to Which the Documents Cited in the International Search Report Are Relevant
Section 422	Notifications Concerning Changes Recorded under Rule 92 ^{bis} .1	Section 509	International Search and Written Opinion of the International Searching Authority on the Basis of a Translation of the International Application
Section 422 ^{bis}	Objections Concerning Changes in the Person of the Applicant Recorded Under Rule 92 ^{bis} .1(a)	Section 510	Refund of Search Fee in Case of Withdrawal of International Application
Section 423	Cancellation of Designations and Elections	Section 511	Rectifications of Obvious Errors Under Rule 91.1
Section 424	[Deleted]	Section 512	Notifications Concerning Representation
Section 425	Notifications Concerning Representation	Section 513	Sequence Listings
Section 426	[Deleted]	Section 514	Authorized Officer
Section 427	[Deleted]	Section 515	Amendment of Established Abstract in Response to Applicant's Comments
Section 428	[Deleted]	Section 516	Notification to Applicant of Submission of Demand After the Expiration of 19 Months from the Priority Date
Section 429	[Deleted]	Section 517	Waivers Under Rules 90.4(d) and 90.5(c)
Section 430	Notification of Designations under Rule 32	Section 518	Guidelines for Explanations Contained in the Written Opinion of the International Searching Authority
Section 431	Publication of Notice of Submission of Demand		
Section 432	Notification to Applicant of Submission of Demand After the Expiration of 19 Months from the Priority Date		
Section 433	Waivers Under Rules 90.4(d) and 90.5(c)		
Section 434	Publication of Information Concerning Waivers Under Rules 90.4(d) and 90.5(c)		
Part 5:	Instructions Relating to the International Searching Authority	Part 6:	Instructions Relating to the International Preliminary Examining Authority
Section 501	Corrections Submitted to the International Searching Authority Concerning Expressions, etc., Not To Be Used in the International Application	Section 601	Notification to Applicant of Submission of Demand After the Expiration of 19 Months From the Priority Date
Section 502	Transmittal of Protest Against Payment of Additional Fee and Decision Thereon Where International Application Is Considered To Lack Unity of Invention	Section 602	Processing of Amendments by the International Preliminary Examining Authority
Section 503	Method of Identifying Documents Cited in the International Search Report and the Written Opinion of the International	Section 603	Transmittal of Protest Against Payment of Additional Fee and Decision Thereon Where International Application Is Considered To Lack Unity of Invention

MANUAL OF PATENT EXAMINING PROCEDURE

Section 604	Guidelines for Explanations Contained in the International Preliminary Examination Report	Section 710	Notification and Publication of Receiving Offices' Requirements and Practices
Section 605	File To Be Used for International Preliminary Examination	Section 711	Electronic Records Management
Section 606	Cancellation of Elections	Section 712	Access to Electronic Records
Section 606 ^{bis}	[Deleted]	Section 713	Provisions Relating to International Authorities and Designated Offices
Section 607	Rectifications of Obvious Errors under Rule 91.1	Part 8:	Instructions Relating to International Applications Containing Large Nucleotide and/or Amino Acid Sequence Listings and/or Tables Relating Thereto
Section 608	Notifications Concerning Representation	Section 801	Filing of International Applications Containing Sequence Listings
Section 609	Withdrawal by Applicant under Rule 90 ^{bis} .1, 90 ^{bis} .2, or 90 ^{bis} .3	Section 802	Format and Identification Requirements Relating to International Applications Containing Sequence Listings
Section 610	[Deleted]	Section 803	Calculation of International Filing Fee for International Applications Containing Sequence Listings and/or Tables
Section 611	Method of Identification of Documents in the International Preliminary Examination Report	Section 804	Preparation, Identification and Transmittal of Copies of International Applications Containing Sequence Listings
Section 612	Authorized Officer	Section 805	Publication and Communication of International Applications Containing Sequence Copies; Priority Documents
Section 613	Invitation to Submit a Request for Refund of Fees under Rule 57.6 or 58.3	Section 806	Sequence Listings for Designated Office
Section 614	Evidence of Right to File Demand		
Section 615	Invitation to Pay Fees Before Date on Which They Are Due		
Section 616	International Preliminary Examination on the Basis of a Translation of the International Application		
Section 617	Waivers Under Rules 90.4(d) and 90.5(c)		
Part 7:	Instructions Relating to the Electronic Filing and Processing of International Applications		
Section 701	Abbreviated Expressions	Annex A	Forms
Section 702	International Applications Filed in Electronic Form	Part I:	Forms Relating to the Receiving Office
Section 703	Filing Requirements; Basic Common Standard	Part II:	Forms Relating to the International Searching Authority
Section 704	Receipt; International Filing Date; Signature; Physical Requirements; Subsequent Documents and Correspondence	Part III:	Forms Relating to the International Bureau
Section 705	Home Copy, Record Copy and Search Copy	Part IV:	Forms Relating to the International Preliminary Examining Authority
Section 706	Backup Copies	Part V:	Forms for Use by the Applicant
Section 707	International filing fee; Fee Reduction	Annex B	Unity of Invention
Section 708	Special Provisions Concerning Legibility, Completeness, Infection by Viruses, Etc.	Part 1:	Instructions Concerning Unity of Invention
Section 709	Means of Communication	Part 2:	Examples Concerning Unity of Invention
		Annex C	Standard for the Presentation of Nucleotide and Amino Acid Sequence Listings in International Patent Applications Under the PCT

ADMINISTRATIVE INSTRUCTIONS UNDER THE PCT

Annex C^{bis}	Technical Requirements for the Presentation of Tables Related to Nucleotide and Amino Acid Sequence Listings in International Patent Applications under the PCT	Annex F	Standard for the Electronic Filing and Processing of International Applications
Annex D	Information from Pamphlet Front Page to Be Included in the Gazette under Rule 86.1(a)(i)	Appendix I	XML DTDs for the E-PCT Standard
Annex E	Information to Be Published in the Gazette under Rule 86.1(a)(v)	Appendix II	PKI Architecture for the E-PCT Standard
		Appendix III	Basic Common Standard for Electronic Filing
		Appendix IV	Use of Physical Media for the E-PCT Standard

PART 1

INSTRUCTIONS RELATING TO GENERAL MATTERS

Section 101

Abbreviated Expressions and Interpretation

(a) In these Administrative Instructions:

(i) "Treaty" means the Patent Cooperation Treaty;

(ii) "Regulations" means the Regulations under the Treaty;

(iii) "Article" means an Article of the Treaty;

(iv) "Rule" means a Rule of the Regulations;

(v) "International Bureau" means the International Bureau as defined in Article 2 (xix) of the Treaty;

(vi) "International Authorities" means the receiving Offices, the International Searching Authorities, the International Preliminary Examining Authorities, and the International Bureau;

(vii) "Annex" means an Annex to these Administrative Instructions, unless the contrary clearly follows from the wording or the nature of the provision, or the context in which the word is used;

(viii) "Form" means a Form contained in Annex A;²

(ix) "WIPO Standard" means a Standard established by the World Intellectual Property Organization;

(x) "Director General" means the Director General as defined in Article 2 (xx) of the Treaty.

(b) The Annexes are part of these Administrative Instructions.

Section 102

Use of the Forms

(a) Subject to paragraphs (b) to (i) and Sections 103 and 114, the International Authorities shall use, or require the use of, the mandatory Forms specified below:

(i) Forms for use by the applicant:

PCT/RO/101 (request Form)

PCT/IPEA/401 (demand Form)

(ii) Forms for use by the receiving Offices:

PCT/RO/103 PCT/RO/115 PCT/RO/150

PCT/RO/104 PCT/RO/116 PCT/RO/151

PCT/RO/105 PCT/RO/117 PCT/RO/152

PCT/RO/106 PCT/RO/118 PCT/RO/153

PCT/RO/107 PCT/RO/123 PCT/RO/154

PCT/RO/109 PCT/RO/126 PCT/RO/155

PCT/RO/110 PCT/RO/133 PCT/RO/156

PCT/RO/111 PCT/RO/136 PCT/RO/157

PCT/RO/112 PCT/RO/143

PCT/RO/113 PCT/RO/147

(iii) Forms for use by the International Searching Authorities:

PCT/ISA/201 PCT/ISA/212 PCT/ISA/233

PCT/ISA/202 PCT/ISA/217 PCT/ISA/234

PCT/ISA/203 PCT/ISA/218 PCT/ISA/235

PCT/ISA/205 PCT/ISA/219 PCT/ISA/236

PCT/ISA/206 PCT/ISA/220 PCT/ISA/237

PCT/ISA/209 PCT/ISA/225

PCT/ISA/210 PCT/ISA/228

(iv) Forms for use by the International Bureau:

PCT/IB/301 PCT/IB/325 PCT/IB/357

PCT/IB/304 PCT/IB/326 PCT/IB/358

PCT/IB/305 PCT/IB/331 PCT/IB/360

²Annex A is published separately by the World Intellectual Property Organization.

ADMINISTRATIVE INSTRUCTIONS UNDER THE PCT

PCT/IB/306	PCT/IB/332	PCT/IB/366
PCT/IB/307	PCT/IB/335	PCT/IB/367
PCT/IB/308	PCT/IB/336	PCT/IB/368
PCT/IB/310	PCT/IB/337	PCT/IB/369
PCT/IB/311	PCT/IB/338	PCT/IB/370
PCT/IB/313	PCT/IB/339	PCT/IB/371
PCT/IB/314	PCT/IB/344	PCT/IB/373
PCT/IB/315	PCT/IB/345	PCT/IB/374
PCT/IB/316	PCT/IB/346	PCT/IB/399
PCT/IB/317	PCT/IB/349	
PCT/IB/318	PCT/IB/350	
PCT/IB/319	PCT/IB/351	
PCT/IB/320	PCT/IB/353	
PCT/IB/321	PCT/IB/354	
PCT/IB/323	PCT/IB/356	

(v) Forms for use by the International Preliminary Examining Authorities:

PCT/IPEA/402	PCT/IPEA/414	PCT/IPEA/437
PCT/IPEA/404	PCT/IPEA/415	PCT/IPEA/440
PCT/IPEA/405	PCT/IPEA/416	PCT/IPEA/441
PCT/IPEA/407	PCT/IPEA/420	PCT/IPEA/442
PCT/IPEA/408	PCT/IPEA/425	PCT/IPEA/443
PCT/IPEA/409	PCT/IPEA/431	PCT/IPEA/444
PCT/IPEA/412	PCT/IPEA/436	

(b) Slight variations in layout necessary in view of the printing of the Forms referred to in paragraph (a) in various languages are permitted.

(c) Slight variations in layout in the Forms referred to in paragraph (a)(ii) to (v) are permitted to the extent necessary to meet the particular office requirements of the International Authorities, in particular in view of the production of the Forms by computer or of the use of window envelopes.

(d) Where the receiving Office, the International Searching Authority and/or the International Preliminary Examining Authority are each part of the same Office, the obligation to use the Forms referred to in paragraph (a) does not extend to communications within that same Office.

(e) The annexes to Forms PCT/RO/106, PCT/RO/118, PCT/ISA/201, PCT/ISA/205, PCT/ISA/206, PCT/ISA/210, PCT/ISA/219, PCT/IB/313, PCT/IB/336, PCT/IPEA/404, PCT/IPEA/405 and PCT/IPEA/415 may be omitted in cases where they are not used.

(f) The notes attached to Forms PCT/RO/101 (request Form) and PCT/IPEA/401 (demand Form) shall be distributed by the International Authorities concerned together with the printed versions of those Forms. The notes attached to Form PCT/ISA/220 shall accompany the Form when sent to the applicant.

(g) The use of Forms other than those referred to in paragraph (a) is optional.

(h) Where the request or the demand is presented as a computer print-out, such print-out shall be prepared as follows:

(i) the layout and contents of the request and the demand when presented as computer print-outs shall correspond to the format of Forms PCT/RO/101 (request Form) and PCT/IPEA/401 (demand Form) (“the printed Forms”), with the same information being presented on the corresponding pages;

(ii) all boxes shall be drawn by solid lines; double lines may be presented as single lines;

(iii) the box numbers and box titles shall be included even where no information is supplied therein;

(iv) the boxes for use by the International Authorities shall be at least as large as those on the printed Forms;

(v) all other boxes shall be within one cm in size of those on the printed Forms;

(vi) all text shall be 9 points or larger in size;

(vii) titles and other information shall be clearly distinguished;

(viii) explanatory notes presented in italics on the printed Forms may be omitted.

(i) Other formats permitted for the presentation of the request and the demand as computer print-outs may be determined by the Director General. Any such format shall be published in the Gazette.

Section 102^{bis}

Filing of Request in PCT-EASY Format Together with PCT-EASY Diskette Containing Request Data and Abstract

(a) Pursuant to Rule 89^{ter}, any receiving Office may, if it is prepared to do so, accept the filing with it of any international application containing the request presented as a computer print-out prepared using the PCT-EASY software made available by the International Bureau (“request in PCT-EASY format”) together with a computer diskette, prepared using that software, containing a copy in electronic form of the data contained in the request and of the abstract (“PCT-EASY diskette”).

(b) Any receiving Office which, under paragraph (a), accepts the filing of requests in PCT-EASY format together with PCT-EASY diskettes shall notify the International Bureau accordingly. The International Bureau shall promptly publish any such information in the Gazette.

(c) Item 3(a) of the Schedule of Fees annexed to the Regulations shall apply to reduce the fees payable in respect of an international application containing the request in PCT-EASY format filed, together with a PCT-EASY diskette, with a receiving Office which, under paragraph (a), accepts the filing of such international applications.

Section 103

Languages of the Forms Used by International Authorities

(a) The language of the Forms used by any receiving Office shall be the same as the language in which the international application is filed, provided that:

(i) where the international application is to be published in the language of a translation required under Rule 12.3(a) or 12.4(a), the receiving Office shall use the Forms in such language;

(ii) the receiving Office may, in its communications to the applicant, use the Forms in any other language being one of its official languages.

(b) Subject to Section 104(b), the language or languages of the Forms to be used by any International Searching Authority shall be specified in the applicable agreement referred to in Article 16(3)(b).

(c) Subject to Section 104(b), the language or languages of the Forms to be used by any International Preliminary Examining Authority shall be specified in the applicable agreement referred to in Article 32(3).

(d) The language of any Form used by the International Bureau shall be English where the language of the international application is English, and it shall be French where the language of the international application is French. Where the language of the international application is neither English nor French, the language of any Form used by the International Bureau in its communications to any other International Authority shall be English or French according to the wishes of such Authority, and in its communications to the applicant it shall be English or French according to the wishes of the applicant.

Section 104

Language of Correspondence in Cases Not Covered by Rule 92.2

(a) The language of any letter from the applicant to the receiving Office shall be the same as the language of the international application to which such letter relates, provided that, where the international application is to be published in the language of a translation required under Rule 12.3(a) or 12.4(a), any letter shall be in such language. However, the receiving Office may expressly authorize the use of any other language.

(b) The language of any letter to the International Bureau shall be English where the language of the international application is English, and it shall be French where the language of the international application is French. Where the language of the international application is neither English nor French, the language of any letter to the International Bureau shall be English or French, provided that any copy, sent to the International Bureau as a notification addressed to it, of a Form sent to the applicant by the receiving Office, the International Searching Authority or the International Preliminary Examining Authority, does not require translation into English or French.

Section 105

Identification of International Application with Two or More Applicants

Where any international application indicates two or more applicants, it shall be sufficient, for the purpose of identifying that application, to indicate, in any Form or correspondence relating to such application, the name of the applicant first named in the request. The provisions of the first sentence of this Section do not apply to the demand.

Section 106

Change of Common Representative

Where a change is recorded under Rule 92^{bis}.1(a) in the person of an applicant who was considered to be the common representative under Rule 90.2(b), the new applicant shall be considered to be the common representative under Rule 90.2(b) if he is entitled according to Rule 19.1 to file an international application with the receiving Office.

Section 107

Identification of International Authorities and of Designated and Elected Offices

(a) Whenever the nature of any communication from or to the applicant, from or to any International Authority or, before national processing or examination has started, from or to any designated or elected Office so permits, any International Authority or any designated or elected Office may be indicated in the communication by the two-letter code referred to in Section 115.

(b) The indication of a receiving Office, an International Searching Authority, an International Preliminary Examining Authority or a designated or elected Office shall be preceded by the letters “RO,” “ISA,” “IPEA,” “DO,” or “EO,” respectively, followed by a slant (e.g., “RO/JP,” “ISA/US,” “IPEA/SE,” “DO/EP,” “EO/AU”).

Section 108

Correspondence Intended for the Applicant

(a) For the purpose of this Section, where there are two or more agents whose appointments are in

force, “first mentioned agent” means the agent first mentioned in the document containing the appointments or, where the appointments are contained in two or more documents, in that which was filed first.

(b) Where a sole applicant has appointed an agent or agents under Rule 90.1(a), correspondence intended for the applicant from the International Authorities shall, subject to paragraph (d), be addressed to the agent or, where applicable, to the first mentioned agent.

(c) Where there are two or more applicants, correspondence intended for the applicants from the International Authorities shall, subject to paragraph (d), be addressed:

(i) if no common agent has been appointed under Rule 90.1—to the common representative or, where applicable, to his agent or first mentioned agent; or

(ii) if the applicants have appointed a common agent or common agents under Rule 90.1(a)—to that common agent or, where applicable, to the first mentioned common agent.

(d) Where an agent has or agents have been appointed under Rule 90.1(b), (c) or (d)(ii), paragraphs (b) and (c) shall apply to correspondence intended for the applicant relating to the procedure before the International Searching Authority or the International Preliminary Examining Authority, as the case may be, as if those paragraphs referred to the agent or agents so appointed.

(e) Where, in accordance with paragraph (c), correspondence intended for the applicants from the International Authorities is to be addressed to the common representative but the indication required under Rule 4.5(a)(ii) has not been provided for the common representative, correspondence shall be addressed:

(i) to the first applicant named in the request who is entitled according to Rule 19.1 to file an international application with the receiving Office and in respect of whom the indication required under Rule 4.5(a)(ii) has been provided; or, if there is no such applicant,

(ii) to the applicant first named in the request who is entitled according to Article 9 to file an international application and in respect of, whom the indication required under Rule 4.5(a)(ii) has been provided; or, if there is no such applicant,

(iii) to the applicant first named in the request in respect of whom the indication required under Rule 4.5(a)(ii) has been provided.

Section 109

File Reference

(a) Where any document submitted by the applicant contains an indication of a file reference, that reference shall not exceed 12 characters in length and may be composed of either letters of the Latin alphabet or Arabic numerals, or both.

(b) Correspondence from International Authorities intended for the applicant shall indicate any such file reference.

Section 110

Dates

Any date in the international application, or used in any correspondence emanating from International Authorities relating to the international application, shall be indicated by the Arabic number of the day, by the name of the month, and by the Arabic number of the year. The receiving Office, where the applicant has not done so, or the International Bureau, where the applicant has not done so and the receiving Office fails to do so, shall, after, above, or below any date indicated by the applicant in the request, repeat the date, in parentheses, by indicating it by two-digit Arabic numerals each for the number of the day and for the number of the month followed by the number of the year in four digits, in that order and with a period, slant or hyphen after the digit pairs of the day and of the month (for example, “20 March 2004 (20.03.2004),” “20 March 2004 (20/03/2004),” or “20 March 2004 (20-03-2004)”).

Section 111

[Deleted]

Section 112

Ceasing of Effect Under Articles 24(1)(iii) and 39(2), Review Under Article 25(2) and Maintaining of Effect Under Articles 24(2) and 39(3)

(a) Each national Office shall, in its capacity as designated Office, notify the International Bureau once a year of:

(i) the number of international applications in respect of which, during the preceding calendar year, the time limit applicable under Article 22 has expired;

(ii) the number of international applications in respect of which, during the preceding calendar year, the requirements provided for in Article 22 have not been complied with before the expiration of the time limit applicable under that Article, with the consequence that the effects of the international applications concerned have ceased under Article 24(1)(iii).

(b) Each national Office shall, in its capacity as elected Office, notify the International Bureau once a year of:

(i) the number of international applications in respect of which, during the preceding calendar year, the time limit applicable under Article 39(1) has expired;

(ii) the number of international applications in respect of which, during the preceding calendar year, the requirements provided for in Article 39(1) have not been complied with before the expiration of the time limit applicable under that Article, with the consequence that the effects of the international applications concerned have ceased under Article 39(3).

(c) Where, under Article 25(2), the designated Office decides that the refusal, declaration or finding referred to in Article 25(1) was not justified, it shall promptly notify the International Bureau that it will treat the international application as if the error or omission referred to in Article 25(2) had not occurred. The notification shall preferably contain the reasons for the decision of the designated Office.

(d) Where, under Article 24(2) or under Article 39(3), the designated or elected Office maintains the effect provided for in Article 11(3), it shall promptly notify the International Bureau accordingly. The notification shall preferably contain the reasons for the decision of the designated or elected Office.

Section 113

Special Fees Payable to the International Bureau

(a) The special publication fee provided for in Rule 48.4 shall be 200 Swiss francs.

(b) The special fee provided for in Rule 91.1(f) shall be payable to the International Bureau and shall be 50 Swiss francs plus 12 Swiss francs for each sheet in excess of one. Where that fee has not been paid before the time of the completion of the technical preparations for international publication, the request for rectification shall not be published. Where the last sentence of Rule 91.1(f) applies and the said fee has not been paid before the time of the communication of the international application under Article 20, a copy of the request for rectification shall not be included in that communication.

(c) The special fee provided for in Rule 26^{bis}.2(c) shall be payable to the International Bureau and shall be 50 Swiss francs plus 12 Swiss francs for each sheet in excess of one. Where that fee has not been paid before the time of the completion of the technical preparations for international publication, the information concerning the priority claim which was considered not to have been made shall not be

published. Where the last sentence of Rule 26^{bis}.2(c) applies and the said fee has not been paid before the time of the communication of the international application under Article 20, a copy of the information concerning the priority claim which was considered not to have been made shall not be included in that communication.

Section 114

[Deleted]

Section 115

Indications of States, Territories, and Intergovernmental Organizations

The indication of a State, territory, or intergovernmental organization shall be made either by its full name, by a generally accepted short title which, if the indications are in English or French, shall be as appears in WIPO Standard ST.3 (Recommended Standard Two-Letter Code for the Representation of Countries, and of Other Entities and International Organizations Issuing or Registering Industrial Property Titles), or by the two-letter code as appears in that Standard.³

³ Published in the WIPO Handbook on Industrial Property Information and Documentation.

PART 2

INSTRUCTIONS RELATING TO THE INTERNATIONAL APPLICATION

Section 201

Language of the International Application

The language in which the international application is filed shall preferably be indicated in the request.

Section 202

[Deleted]

Section 203

Different Applicants for Different Designated States

(a) Different applicants may be indicated for different States designated for a regional patent.

(b) Where a particular State has been designated for both a national patent and a regional patent, the same applicant or applicants shall be indicated for both designations.

Section 204

Headings of the Parts of the Description

The headings of the parts of the description should be as follows:

(i) for matter referred to in Rule 5.1(a)(i), “Technical Field”;

(ii) for matter referred to in Rule 5.1(a)(ii), “Background Art”;

(iii) for matter referred to in Rule 5.1(a)(iii), “Disclosure of Invention”;

(iv) for matter referred to in Rule 5.1(a)(iv), “Brief Description of Drawings”;

(v) for matter referred to in Rule 5.1(a)(v), “Best Mode for Carrying Out the Invention,” or, where appropriate, “Mode(s) for Carrying Out the Invention”;

(vi) for matter referred to in Rule 5.1(a)(vi), “Industrial Applicability”;

(vii) for matter referred to in Rule 5.2(a), “Sequence Listing”;

(viii) for matter referred to in Rule 5.2(b), “Sequence Listing Free Text.”

Section 205

Numbering and Identification of Claims upon Amendment

(a) Amendments to the claims under Article 19 or Article 34(2)(b) may be made either by cancelling one or more entire claims, by adding one or more new claims or by amending the text of one or more of the claims as filed. All the claims appearing on a replacement sheet shall be numbered in Arabic numerals. Where a claim is cancelled, no renumbering of the other claims shall be required. In all cases where claims are renumbered, they shall be renumbered consecutively.

(b) The applicant shall, in the letter referred to in the second and third sentences of Rule 46.5(a) or in the second and fourth sentences of Rule 66.8(a), indicate the differences between the claims as filed and the claims as amended. He shall, in particular, indicate in the said letter, in connection with each claim appearing in the international application (it being understood that identical indications concerning several claims may be grouped), whether:

(i) the claim is unchanged;

(ii) the claim is cancelled;

(iii) the claim is new;

(iv) the claim replaces one or more claims as filed;

(v) the claim is the result of the division of a claim as filed.

Section 206

Unity of Invention

The determination by the International Searching Authority, the International Preliminary Examining Authority and the designated and elected Offices whether an international application complies with the requirement of unity of invention under Rule 13 shall be made in accordance with Annex B.

Section 207

Arrangement of Elements and Numbering of Sheets of the International Application

(a) In effecting the sequential numbering of the sheets of the international application in accordance with Rule 11.7, the elements of the international application shall be placed in the following order: the request, the description (other than any sequence listing part thereof), the claims, the abstract, the drawings, the sequence listing part of the description (where applicable).

(b) The sequential numbering of the sheets shall be effected by using the following separate series of numbering:

(i) the first series applying to the request only and commencing with the first sheet of the request,

(ii) the second series commencing with the first sheet of the description (other than any sequence listing part thereof) and continuing through the claims until the last sheet of the abstract,

(iii) if applicable, a further series applying to the sheets of the drawings only and commencing with the first sheet of the drawings; the number of each sheet of the drawings shall consist of two Arabic numerals separated by a slant, the first being the sheet number and the second being the total number of sheets of drawings (for example, 1/3, 2/3, 3/3), and

(iv) if applicable, preferably, a further series applying to the sequence listing part of the description commencing with the first sheet of that part.

Section 208

Sequence Listings

Any nucleotide and/or amino acid sequence listing (“sequence listing”) filed as part of the international application, or furnished together with the international application or subsequently (whether in printed form or computer readable form), shall comply with Annex C.

Section 209

Indications as to Deposited Biological Material on a Separate Sheet

(a) To the extent that any indication with respect to deposited biological material is not con-

tained in the description, it may be given on a separate sheet. Where any such indication is so given, it shall preferably be on Form PCT/RO/134 and, if furnished at the time of filing, the said Form shall, subject to paragraph (b), preferably be attached to the request and referred to in the check list referred to in Rule 3.3 (a)(ii).

(b) For the purposes of the Israel Patent Office, the Japan Patent Office, the Korean Intellectual Property Office, the Mexican Institute of Industrial Property, and the Turkish Patent Institute as designated Offices, paragraph (a) applies only to the extent that the said Form or sheet is included as one of the sheets of the description of the international application at the time of filing.

Section 210

[Deleted]

Section 211

Declaration as to the Identity of the Inventor

(a) Any declaration as to the identity of the inventor, referred to in Rule 4.17(i), shall be worded as follows:

“Declaration as to the identity of the inventor (Rules 4.17(i) and 51^{bis}.1(a)(i)):

in relation to [this] international application [No. PCT/...],

(i) ... (*name*) of ... (*address*) is the inventor of the subject matter for which protection is sought by way of [the] [this] international application

(ii) this declaration is made for the purposes of (*include as applicable*):

(a) all designations [except the designation of the United States of America]

(b) the following designations for national and/or regional patents: ...”

(b) This declaration need not be made if the name and address of the inventor are otherwise indicated in the request.

(c) This declaration may, where applicable, be combined, in accordance with Section 212(b), with the declaration referred to in Section 212(a).

Section 212

Declaration as to the Applicant's Entitlement to Apply for and Be Granted a Patent

(a) Any declaration as to the applicant's entitlement, as at the international filing date, to apply for and be granted a patent, referred to in Rule 4.17(ii), shall be worded as follows, with such inclusion, omission, repetition and re-ordering of the matters listed as items (i) to (viii) as is necessary to explain the applicant's entitlement:

"Declaration as to the applicant's entitlement, as at the international filing date, to apply for and be granted a patent (Rules 4.17(ii) and 51^{bis}.1(a)(ii)), in a case where the declaration under Rule 4.17(iv) is not appropriate:

in relation to [this] international application [No. PCT/...],

... (*name*) is entitled to apply for and be granted a patent by virtue of the following:

(i) ... (*name*) of ... (*address*) ... is the inventor of the subject matter for which protection is sought by way of [the] [this] international application

(ii) ... (*name*) [is] [was] entitled as employer of the inventor, ... (*inventor's name*)

(iii) an agreement between ... (*name*) and ... (*name*), dated ...

(iv) an assignment from ... (*name*) to ... (*name*), dated ...

(v) consent from ... (*name*) in favor of ... (*name*), dated ...

(vi) a court order issued by ... (*name of court*), effecting a transfer from ... (*name*) to ... (*name*), dated ...

(vii) transfer of entitlement from ... (*name*) to ... (*name*) by way of ... (*specify kind of transfer*), dated ...

(viii) the applicant's name changed from ... (*name*) to ... (*name*) on ... (*date*)

(ix) this declaration is made for the purposes of (*include as applicable*):

(a) all designations [except the designation of the United States of America]

(b) the following designations for national and/or regional patents: ..."

(b) The declaration referred to in paragraph (a) may, where applicable, be combined with the declaration referred to in Section 211(a), in which case the introductory phrase shall be worded as follows and the remainder of the combined declaration shall be worded as prescribed in paragraph (a):

"Combined declaration as to the applicant's entitlement, as at the international filing date, to apply for and be granted a patent (Rules 4.17(ii) and 51^{bis}.1(a)(ii)) and as to the identity of the inventor (Rules 4.17(i) and 51^{bis}.1(a)(i)), in a case where the declaration under Rule 4.17(iv) is not appropriate:"

Section 213

Declaration as to the Applicant's Entitlement to Claim Priority of Earlier Application

Any declaration as to the applicant's entitlement, as at the international filing date, to claim priority of the earlier application, referred to in Rule 4.17(iii), shall be worded as follows, with such inclusion, omission, repetition and re-ordering of the matters listed as items (i) to (viii) as is necessary to explain the applicant's entitlement:

"Declaration as to the applicant's entitlement, as at the international filing date, to claim the priority of the earlier application specified below, where the applicant is not the applicant who filed the earlier application or where the applicant's name has changed since the filing of the earlier application (Rules 4.17(iii) and 51^{bis}.1(a)(iii)):

in relation to [this] international application [No. PCT/...],

... (*name*) is entitled to claim priority of earlier application No. ... by virtue of the following:

(i) the applicant is the inventor of the subject matter for which protection was sought by way of the earlier application

(ii) ... (*name*) [is] [was] entitled as employer of the inventor, ... (*inventor's name*)

(iii) an agreement between ... (*name*) and ... (*name*), dated ...

ADMINISTRATIVE INSTRUCTIONS UNDER THE PCT

(iv) an assignment from ... (*name*) to ... (*name*), dated ...

(v) consent from ... (*name*) in favor of ... (*name*), dated ...

(vi) a court order, issued by ... (*name of court*), effecting a transfer from ... (*name*) to ... (*name*), dated ...

(vii) transfer of entitlement from ... (*name*) to ... (*name*) by way of ... (*specify kind of transfer*), dated ...

(viii) the applicant's name changed from ... (*name*) to ... (*name*) on ... (*date*)

(ix) this declaration is made for the purposes of (*include as applicable*):

(a) all designations

(b) the following designations for national and/or regional patents: ...”

Section 214

Declaration of Inventorship

(a) A declaration of inventorship, referred to in Rule 4.17(iv), that is made for the purposes of the designation of the United States of America shall be worded as follows:

“Declaration of inventorship (Rules 4.17(iv) and 51^{bis}.1(a)(iv)) for the purposes of the designation of the United States of America:

I hereby declare that I believe I am the original, first and sole (if only one inventor is listed below) or joint (if more than one inventor is listed below) inventor of the subject matter which is claimed and for which a patent is sought.

This declaration is directed to the international application of which it forms a part (if filing declaration with application).

This declaration is directed to international application No. PCT/... (if furnishing declaration pursuant to Rule 26^{ter}).

I hereby declare that my residence, mailing address, and citizenship are as stated next to my name.

I hereby state that I have reviewed and understand the contents of the above-identified interna-

tional application, including the claims of said application. I have identified in the request of said application, in compliance with PCT Rule 4.10, any claim to foreign priority, and I have identified below, under the heading “Prior Applications,” by application number, country or Member of the World Trade Organization, day, month and year of filing, any application for a patent or inventor's certificate filed in a country other than the United States of America, including any PCT international application designating at least one country other than the United States of America, having a filing date before that of the application on which foreign priority is claimed.

I hereby acknowledge the duty to disclose information that is known by me to be material to patentability as defined by 37 C.F.R. § 1.56, including for continuation-in-part applications, material information which became available between the filing date of the prior application and the PCT international filing date of the continuation-in-part application.

I hereby declare that all statements made herein of my own knowledge are true and that all statements made on information and belief are believed to be true; and further that these statements were made with the knowledge that willful false statements and the like so made are punishable by fine or imprisonment, or both, under Section 1001 of Title 18 of the United States Code and that such willful false statements may jeopardize the validity of the application or any patent issued thereon.

Name: ...

Residence: ... (city and either US state, if applicable, or country)

Mailing Address: ...

Citizenship: ...

Prior Applications: ...

Inventor's Signature: ... (if not contained in the request, or if declaration is corrected or added under Rule 26^{ter} after the filing of the international application. The signature must be that of the inventor, not that of the agent)

Date: ... (of signature which is not contained in the request, or of the declaration that is corrected or added under Rule 26^{ter} after the filing of the international application)”

(b) Where there is more than one inventor and all inventors do not sign the same declaration referred to in paragraph (a), each declaration shall indicate the names of all the inventors.

(c) Any correction or addition under Rule 26^{ter}.1 of a declaration referred to in paragraph (a) shall take the form of a declaration referred to in that paragraph and be signed by the inventor. In addition, any such correction shall be entitled “Supplemental declaration of inventorship (Rules 4.17(iv) and 51^{bis}.1(a)(iv))”.

Section 215

Declaration as to Non-Prejudicial Disclosures or Exceptions to Lack of Novelty

Any declaration as to non-prejudicial disclosures or exceptions to lack of novelty shall be worded as follows, with such inclusion, omission, repetition and re-ordering of the matters listed as items (i) to (iv) as is necessary:

“Declaration as to non-prejudicial disclosures or exceptions to lack of novelty (Rules 4.17(v) and 51^{bis}.1(a)(v)):

in relation to [this] international application [No. PCT/...],

... (*name*) declares that the subject matter claimed in [the] [this] international application was disclosed as follows:

(i) kind of disclosure (*include as applicable*):

(a) international exhibition

(b) publication

(c) abuse

(d) other: ...(*specify*)

(ii) date of disclosure: ...

(iii) title of disclosure (*if applicable*): ...

(iv) place of disclosure (*if applicable*): ...

(v) this declaration is made for the purposes of (*include as applicable*):

(a) all designations

(b) the following designations for national and/or regional patents: ...”

Section 216

Notice of Correction or Addition of a Declaration Under Rule 26^{ter}

Any notice referred to in Rule 26^{ter}.1 shall consist of a replacement sheet containing a corrected declaration, or of an additional sheet containing a declaration, and an accompanying letter explaining the correction or addition.

PART 3

INSTRUCTIONS RELATING TO THE RECEIVING OFFICE

Section 301

Notification of Receipt of Purported International Application

Before the determination under Article 11(1), the receiving Office may notify the applicant of the receipt of the purported international application. The notification should indicate the date of actual receipt and the international application number of the purported international application referred to in Section 307 as well as, where useful for purposes of identification, the title of the invention.

Section 302

Priority Claim Considered Not To Have Been Made

Where the receiving Office declares, under Rule 26^{bis}.2(b), that a priority claim is considered not to have been made, that Office shall enclose the priority claim concerned within square brackets, draw a line between the square brackets, while still leaving legible the indications concerned, and enter, in the margin, the words “NOT TO BE CONSIDERED FOR PCT PROCEDURE (RO)” or their equivalent in the language of publication of the international application, and shall notify the applicant accordingly. If copies of the international application have already been sent to the International Bureau and the International Searching Authority, the receiving Office shall also notify that Bureau and that Authority.

Section 303

Deletion of Additional Matter in the Request

(a) Where, under Rule 4.18(b), the receiving Office deletes *ex officio* any matter contained in the request, it shall do so by enclosing such matter within square brackets and entering, in the margin, the words “DELETED BY RO” or their equivalent in the language of publication of the international application, and shall notify the applicant accordingly. If copies of the international application have already been sent to the International Bureau and the International Search-

ing Authority, the receiving Office shall also notify that Bureau and that Authority.

(b) The receiving Office shall not delete *ex officio* any indication made in declarations referred to in Rule 4.17 which are contained in the request.

Section 304

Invitation to Pay Fees Before Date on Which They Are Due

(a) If the receiving Office finds, before the date on which they are due, that the transmittal fee, the international filing fee (including any supplement per sheet over 30) or the search fee are lacking in whole or in part, it may invite the applicant to pay the missing amounts within one month from the date of receipt of the international application.

(b) If the receiving Office finds, before the date on which they are due, that the designation fees for designations made under Rule 4.9(a) are lacking in whole or in part, it may invite the applicant to pay the missing amount within the time limit applicable under Rule 15.4(b).

(c) If the receiving Office finds that the applicant filed a written notice under Rule 4.9(c)(i), but failed to pay the designation fees and/or the confirmation fee under Rule 4.9(c)(ii) or that the amount paid is not sufficient, it may invite the applicant to pay the missing amount within the time limit under Rule 4.9(b)(ii).

Section 305

Identifying the Copies of the International Application

(a) Where, under Rule 11.1(a), the international application has been filed in one copy, the receiving Office shall, after preparing under Rule 21.1(a) the additional copies required under Article 12(1), mark,

(i) the words “RECORD COPY” in the upper left-hand corner of the first page of the original copy,

(ii) in the same space on one additional copy, the words “SEARCH COPY”, and

(iii) in the same space on the other such copy, the words “HOME COPY,” or their equivalent in the language of publication of the international application.

(b) Where, under Rule 11.1(b), the international application has been filed in more than one copy, the receiving Office shall choose the copy most suitable for reproduction purposes, and mark the words “RECORD COPY,” or their equivalent in the language of publication of the international application, in the upper left-hand corner of its first page. After verifying the identity of any additional copies and, if applicable, preparing under Rule 21.1(b) the home copy, it shall mark, in the upper left-hand corner of the first page of one such copy, the words “SEARCH COPY,” and, in the same space on the other such copy, the words “HOME COPY,” or their equivalent in the language of publication of the international application.

Section 305^{bis}

Preparation, Identification and Transmittal of the Copies of the Translation of the International Application

(a) Where a translation of the international application is furnished under Rule 12.3, the receiving Office shall:

(i) be responsible for the prompt preparation of any additional copies required where the translation is furnished in less than the number of copies required for the purposes of this paragraph, and shall have the right to fix a fee for performing that task and to collect such fee from the applicant;

(ii) mark the words “RECORD COPY-TRANSLATION (RULE 12.3)” in the upper left-hand corner of the first page of the original copy of the translation and transmit that copy to the International Bureau;

(iii) mark the words “SEARCH COPY-TRANSLATION (RULE 12.3)” in the same space on one additional copy of the translation which, together with a copy of the request marked “SEARCH COPY” under Section 305(a)(ii), is considered pursuant to Rule 23.1(b) to be the search copy, and transmit such search copy to the International Searching Authority; and

(iv) mark the words “HOME COPY-TRANSLATION (RULE 12.3)” in the same space on

the other such copy of the translation, and keep that copy in its files.

(b) The receiving Office may, when marking the copies of the translation under paragraph (a), use, instead of the words referred to in that paragraph, the equivalent of those words in the language of publication of the international application.

(c) Where a translation of the international application is furnished under Rule 12.4, the receiving Office shall:

(i) be responsible for the prompt preparation of any additional copies required where the translation is furnished in less than the number of copies required for the purposes of this paragraph, and shall have the right to fix a fee for performing that task and to collect such fee from the applicant;

(ii) mark the words “RECORD COPY – TRANSLATION (RULE 12.4)” in the upper left-hand corner of the first page of the original copy of the translation and transmit that copy to the International Bureau; and

(iii) mark the words “HOME COPY – TRANSLATION (RULE 12.4)” in the same space on the other such copy of the translation, and keep that copy in its files.

Section 306

Delayed Transmittal of Search Copy

Where the search copy will be transmitted to the International Searching Authority after the date on which the record copy is transmitted to the International Bureau, the receiving Office shall notify the International Bureau. The notification may be made by marking a check-box provided for this purpose on the request.

Section 307

System of Numbering International Applications

(a) Papers purporting to be an international application under Rule 20.1(a) shall be marked with the international application number, consisting of the letters “PCT,” a slant, the two-letter code referred to in Section 115, indicating the receiving Office, a four-digit indication of the year in which such papers were first received, a slant and a six-digit number, allotted in sequential order corresponding to the order in which the international applications are received (e.g.,

ADMINISTRATIVE INSTRUCTIONS UNDER THE PCT

“PCT/SE2004/000001”). Where the International Bureau acts as receiving Office, the two-letter code “IB” shall be used.

(b) If a negative determination is made under Rule 20.7 or a declaration is made under Article 14 (4), the letters “PCT” shall be deleted by the receiving Office from the indication of the international application number on any papers marked previously with that number, and the said number shall be used without such letters in any future correspondence relating to the purported international application.

Section 308

Marking of the Sheets of the International Application and of the Translation Thereof

The receiving Office shall indelibly mark the international application number referred to in Section 307 in the upper right-hand corner of each sheet of each copy of the purported international application and of any translation of the international application furnished under Rule 12.3 or 12.4.

Section 309

Procedure in the Case of Later Submitted Sheets

(a) The receiving Office shall indelibly mark any sheet received on a date later than the date on which sheets were first received with the date on which it received that sheet, inserted immediately below the international application number referred to in Section 307.

(b) The receiving Office shall, in the case of later submitted sheets received within the time limits referred to in Rule 20.2(a)(i) and (ii):

(i) effect the required correction of the international filing date, or, where no international filing date has yet been accorded, of the date of receipt of the purported international application;

(ii) notify the applicant of the correction effected under item (i), above;

(iii) where transmittals under Article 12(1) have already been made, notify the International Bureau and the International Searching Authority of any correction effected under item (i), above, by transmitting a copy of the corrected first and last sheets of the request, and forward the later submitted sheets to the said Bureau and a copy thereof to the said Authority;

(iv) where transmittals under Article 12(1) have not yet been made, attach the later submitted sheets to the record copy and a copy thereof to the search copy.

(c) The receiving Office shall, in the case of later submitted sheets received after the expiration of the time limit referred to in Rule 20.2(a)(i):

(i) notify the applicant of that fact and of the date of receipt of the later submitted sheets;

(ii) where transmittals under Article 12(1) have already been made, forward the later submitted sheets to the International Bureau with the indication on the bottom of each sheet of the words: “NOT TO BE TAKEN INTO CONSIDERATION FOR THE PURPOSES OF INTERNATIONAL PROCESSING” or their equivalent in the language of publication of the international application;

(iii) where transmittals under Article 12(1) have not yet been made, attach the later submitted sheets to the record copy with the indication referred to in item (ii).

(d) The receiving Office shall, in the case of later submitted sheets received after the expiration of the time limit referred to in Rule 20.2(a)(ii), proceed as provided in Rule 20.7, unless the applicant has, within the said time limit, complied with the invitation under Article 11 (2)(a) so that an international filing date can be accorded; in the latter case, the receiving Office shall proceed as provided in paragraph (c)(i) to (iii).

Section 310

Procedure in the Case of Missing Drawings

(a) Where the international application refers to drawings which in fact are not included in that application, the receiving Office shall make the indication referred to in Rule 26.6(a) by marking a check-box provided for this purpose on the request.

(b) Section 309(a) shall apply also in the case of drawings received by the receiving Office on a date later than the date on which sheets were first received by that Office.

(c) The receiving Office shall, in the case of missing drawings received within the time limit referred to in Rule 20.2(a)(iii):

(i) effect the required correction of the international filing date, or, where no international filing date has yet been accorded, of the date of receipt of

the purported international application, and delete the indication made under paragraph (a), above;

(ii) notify the applicant of the correction effected under item (i), above;

(iii) where transmittals under Article 12(1) have already been made, notify the International Bureau and the International Searching Authority of any correction effected under item (i), above, by transmitting a copy of the corrected first and last sheets of the request, and forward the later submitted drawings to the said Bureau and a copy thereof to the said Authority;

(iv) where transmittals under Article 12(1) have not yet been made, attach the later submitted drawings to the record copy and a copy thereof to the search copy.

(d) The receiving Office shall, in the case of missing drawings received after the expiration of the time limit referred to in Rule 20.2(a)(iii):

(i) notify the applicant of the fact and of the date of receipt of the later submitted drawings;

(ii) where transmittals under Article 12(1) have already been made, forward the later submitted drawings to the International Bureau with the indication on the bottom of each drawing of the words: "NOT TO BE TAKEN INTO CONSIDERATION (PCT Art. 14(2), 2nd sentence)" or their equivalent in the language of publication of the international application;

(iii) where transmittals under Article 12(1) have not yet been made, attach the later submitted drawings to the record copy with the indication referred to in item (ii).

Section 311

Renumbering in the Case of Deletion, Substitution or Addition of Sheets of the International Application and of the Translation Thereof

(a) The receiving Office shall, subject to Section 207, sequentially renumber the sheets of the international application when necessitated by the addition of any new sheet, the deletion of entire sheets, a change in the order of the sheets or any other reason.

(b) The sheets of the international application shall be provisionally renumbered in the following manner:

(i) when a sheet is deleted, the receiving Office shall either include a blank sheet with the same number and with the word "DELETED," or its equivalent in the language of publication of the international application, below the number, or insert, in brackets, below the number of the following sheet, the number of the deleted sheet with the word "DELETED" or its equivalent in the language of publication of the international application;

(ii) when one or more sheets are added, each sheet shall be identified by the number of the preceding sheet followed by a slant and then by another Arabic numeral such that the additional sheets are numbered consecutively, starting always with number one for the first sheet added after an unchanged sheet (e.g., 10/1, 15/1, 15/2, 15/3, etc.); when later additions of sheets to an existing series of added sheets are necessary, an extra numeral shall be used for identifying the further additions (e.g., 15/1, 15/1/1, 15/1/2, 15/2, etc.).

(c) In the cases mentioned in paragraph (b), it is recommended that the receiving Office should write, below the number of the last sheet, the total number of the sheets of the international application followed by the words "TOTAL OF SHEETS" or their equivalent in the language of publication of the international application. It is further recommended that, at the bottom of any last sheet added, the words "LAST ADDED SHEET" or their equivalent in the language of publication of the international application should be inserted.

(d) Paragraphs (a) to (c) shall apply *mutatis mutandis* to any translation of the international application furnished under Rule 12.3 or 12.4.

Section 312

Notification of Decision Not to Issue Declaration that the International Application Is Considered Withdrawn

Where the receiving Office, after having notified the applicant under Rule 29.4 of its intent to issue a declaration under Article 14(4), decides not to issue such a declaration, it shall notify the applicant accordingly.

Section 313

Documents Filed with the International Application; Manner of Marking the Necessary Annotations in the Check List

(a) Any power of attorney, any priority document, any fee calculation sheet and any separate sheet referred to in Section 209(a) containing indications as to deposited biological material, filed with the international application shall accompany the record copy; any other document referred to in Rule 3.3(a)(ii) shall be sent only at the specific request of the International Bureau. If any document which is indicated in the check list as accompanying the international application is not, in fact, filed at the latest by the time the record copy leaves the receiving Office, that Office shall so note on the check list and the said indication shall be considered as if it had not been made.

(b) Where, under Rule 3.3(b), the receiving Office itself completes the check list, that Office shall enter, in the margin, the words “COMPLETED BY RO” or their equivalent in the language of publication of the international application. Where only some of the indications are completed by the receiving Office, the said words and each indication completed by that Office shall be identified by an asterisk.

(c) Any sequence listing in computer readable form furnished to the receiving Office, or any sequence listing in printed form furnished to the receiving Office subsequent to the filing of the international application, shall be transmitted to the International Searching Authority together with the search copy. Where such a sequence listing is received by the receiving Office after the transmittal of the search copy, that sequence listing shall be promptly transmitted to the International Searching Authority.

Section 314

Correction or Addition of a Priority Claim Under Rule 26^{bis}

(a) Where the applicant, in a notice submitted to the receiving Office, corrects or adds a priority claim under Rule 26^{bis}, that Office shall enter the correction or addition in the request, draw a line through, while still leaving legible, any indication deleted as a result of the correction, and enter, in the margin, the letters “RO.”

(b) The applicant and, if copies of the international application have already been sent to the International Bureau and the International Searching Authority, that Bureau and that Authority shall be promptly notified by the receiving Office of any correction or addition of a priority claim under Rule 26^{bis} and of the date on which it received such correction or addition.

Section 315

[Deleted]

Section 316

Procedure in the Case Where the International Application Lacks the Prescribed Signature

Where, under Article 14(1)(a)(i), the receiving Office finds that the international application is defective in that it lacks the prescribed signature, that Office shall send to the applicant, together with the invitation to correct under Article 14(1)(b), a copy of the relevant sheet of the request part of the international application. The applicant shall, within the prescribed time limit, return said copy after affixing thereto the prescribed signature.

Section 317

Transmittal of a Notice of Correction or Addition of a Declaration Under Rule 26^{ter}.1

If a notice under Rule 26^{ter}.1 is submitted by the applicant to the receiving Office, that Office shall mark the date of receipt on the notice and transmit it promptly to the International Bureau. The notice shall be considered to have been received by the International Bureau on the date marked.

Section 318

Cancellation of Designations of Non-Contracting States

The receiving Office shall cancel *ex officio* the designation of any State which is not a Contracting State, shall enclose that designation within square brackets, shall draw a line between the square brackets while still leaving the designation legible, shall enter, in the margin, the words “CANCELLED EX OFFICIO BY RO” or their equivalent in the language of publication of the international application, and shall promptly

notify the applicant accordingly. If the record copy has already been sent to the International Bureau, the receiving Office shall also notify that Bureau.

Section 319

[Deleted]

Section 320

Invitation to Pay Fees under Rule 16^{bis}.1(a)

When issuing an invitation under Rule 16^{bis}.1(a), the receiving Office shall, if it received moneys from the applicant before the due date, inform the applicant of the fees to which those moneys have been applied.

Section 321

Application of Moneys Received by the Receiving Office in Certain Cases

(a) The receiving Office shall, to the extent that it has received instructions from the applicant as to the fees to which it shall apply moneys received by it from the applicant, apply those moneys accordingly.

(b) Where the receiving Office receives moneys from the applicant which, together with any other moneys so received, are not sufficient to cover in full the transmittal fee (if any), the international filing fee and the search fee (if any), the receiving Office shall, to the extent that it has not received instructions from the applicant as to the fees to which it shall apply the moneys which are available for the purpose, apply those moneys in payment, successively, of the fees set out below to the extent that they are due and unpaid and in the order in which they appear below:

- (i) the transmittal fee;
- (ii) the international filing fee;
- (iii) the search fee.

(c) Where, pursuant to paragraph (b), the receiving Office allocates moneys in payment of the designation fees to cover designations made under Rule 4.9(a), it shall apply them to those fees as follows:

(i) where the applicant indicates to which designation or designations the amount is to be applied, it shall be applied accordingly but, if the amount received is insufficient to cover the designations indicated, it shall be applied in the order chosen by the applicant in indicating the designations;

(ii) to the extent that the applicant has not given the indications referred to in item (i), the amount, or the balance thereof, shall be applied to the designations in the order in which they appear in the request part of the international application;

(iii) where the designation of a State is for the purposes of a regional patent, and provided that the required designation fee is, under the preceding provisions, available for that designation, the designation of any further States for which the same regional patent is sought shall be considered as covered by that fee.

(d) Where the receiving Office receives moneys from the applicant in response to an invitation under Rule 16^{bis}.1 which are not sufficient to cover all the unpaid fees, including, where required, the late payment fee under Rule 16^{bis}.2, the moneys shall be applied in the order referred to in paragraphs (b) and (c) to as many of the fees due, including any late payment fee, as can be covered.

(e) Where, pursuant to Rule 15.5(b), the receiving Office allocates moneys in payment of fees under Rule 15.5(a) in respect of the confirmation under Rule 4.9(c) of designations made under Rule 4.9(b), the receiving Office shall apply those moneys as follows:

(i) where the applicant indicates to which designation or designations the amount is to be applied, it shall be applied accordingly, but, if the amount is insufficient to cover the designations indicated, it shall be applied to the designations in the order chosen by the applicant in indicating the designations;

(ii) to the extent that the applicant has not given the indications referred to in item (i), the amount, or the balance thereof, shall be applied to the designations in the order in which they appear in the notice containing the confirmation;

(iii) where the designation of a State is for the purposes of a regional patent, and provided that the required designation fee is, under the preceding provisions, available for that designation, the designation of any further States for which the same regional patent is sought shall be considered as covered by that fee.

(f) When allocating moneys as provided in paragraph (e), both the designation fee and the confirmation fee must be covered in respect of each designation.

ADMINISTRATIVE INSTRUCTIONS UNDER THE PCT

(g) Where moneys have been applied by the receiving Office in accordance with indications given by the applicant as mentioned in paragraph (c)(i) or (e)(i), the receiving Office shall inform the International Bureau as to the effect of the said indications, preferably by sending the International Bureau a copy of any relevant written communication received from the applicant.

Section 322

Invitation to Submit a Request for Refund of the Search Fee

The receiving Office may, before making a refund of the search fee under Rule 16.2, first invite the applicant to submit a request for the refund.

Section 323

Transmittal of Priority Documents to International Bureau

(a) Any priority document which is submitted to the receiving Office under Rule 17.1(a) shall be transmitted by that Office to the International Bureau together with the record copy or, if received after the record copy has been sent to the International Bureau, promptly after having been received by that Office.

(b) Where the priority document is issued by the receiving Office and the applicant has, not later than 16 months after the priority date, requested the receiving Office under Rule 17.1(b) to prepare and transmit it to the International Bureau, the receiving Office shall, promptly after receipt of such request (“request for priority document”) and, where applicable, the payment of the fee referred to in that Rule, transmit the priority document to the International Bureau. Where such request for priority document has been made but the required fee has not been paid, the receiving Office shall promptly notify the applicant that the request for priority document will be considered not to have been made unless the fee is paid not later than 16 months after the priority date or, in the case referred to in Article 23(2), not later than at the time the processing or examination of the international application is requested.

(c) When transmitting a priority document, the receiving Office shall notify the International Bureau of the date on which it received the priority document or the request for priority document.

(d) Where a request for priority document has, under paragraph (b), been considered not to have been made, the receiving Office shall promptly notify the International Bureau. Where the receiving Office fails to notify the International Bureau accordingly within 17 months from the priority date, the receiving Office shall prepare and transmit the priority document to the International Bureau even though the required fee has not been paid by the applicant.

(e) Where a request for priority document has been received by the receiving Office later than 16 months after the priority date, or where such request has, under paragraph (b), been considered not to have been made, the receiving Office shall promptly notify the applicant accordingly, directing attention to the requirements of Rule 17.1(a).

Section 324

Copy of Notification of the International Application Number and the International Filing Date Under Rule 20.5(c)

The copy, sent to the International Bureau, of the notification of the international application number and the international filing date under Rule 20.5(c) shall also include, if the priority of an earlier application is claimed in the international application, the date of filing—as indicated in the international application—of that earlier application. If the priority of several earlier applications is claimed, the earliest filing date shall be indicated.

Section 325

Corrections of Defects Under Rule 26.4, Rectifications of Obvious Errors Under Rule 91.1, and Corrections Under Rule 9.2

(a) Where the receiving Office receives a correction of defects under Rule 26.4 or authorizes a rectification of an obvious error under Rule 91.1, it shall:

(i) indelibly mark, in the upper right-hand corner of each replacement sheet, the international application number and the date on which that sheet was received;

(ii) indelibly mark, in the middle of the bottom margin of each replacement sheet, the words “SUBSTITUTE SHEET (RULE 26)” (where the replacement sheet contains a correction of defects under Rule 26) or “RECTIFIED SHEET (RULE

91.1)” (where the replacement sheet contains the rectification of an obvious error under Rule 91.1) or their equivalent in the language of publication of the international application;

(iii) indelibly mark on the letter containing the correction or rectification, or accompanying any replacement sheet, the date on which that letter was received;

(iv) keep in its files a copy of the letter containing the correction or rectification or, when the correction or rectification is contained in a replacement sheet, the replaced sheet, a copy of the letter accompanying the replacement sheet, and a copy of the replacement sheet;

(v) subject to item (vi), promptly transmit any letter and any replacement sheet to the International Bureau, and a copy thereof to the International Searching Authority;

(vi) where transmittals under Article 12(1) have not yet been made, transmit any letter and any replacement sheet to the International Bureau together with the record copy and, except where the international application is considered withdrawn and Rule 29.1 (iii) applies, a copy of the said letter or replacement sheet to the International Searching Authority together with the search copy. The record copy and the search copy shall contain any replaced sheet.

(b) Where the receiving Office refuses to authorize the rectification of an obvious error under Rule 91.1, it shall proceed as indicated under paragraph (a)(i), (iii) and (iv) and promptly transmit any letter and any proposed replacement sheet to the International Bureau. If the record copy has not yet been sent to the International Bureau, any letter and any proposed replacement sheet shall be transmitted together with the record copy.

(c) Where the receiving Office receives corrections aimed at complying with Rule 9.1, paragraphs (a) and (b) shall apply *mutatis mutandis*, provided that, where a sheet is marked as indicated in paragraph (a)(ii), the words “SUBSTITUTE SHEET (RULE 9.2)” shall be used.

Section 326

Withdrawal by Applicant Under Rule 90^{bis}.1, 90^{bis}.2 or 90^{bis}.3

(a) The receiving Office shall promptly transmit to the International Bureau any notice from the applicant effecting withdrawal of the international application under Rule 90^{bis}.1, of a designation under Rule 90^{bis}.2 or of a priority claim under Rule 90^{bis}.3 which has been filed with it together with an indication of the date of receipt of the notice. If the record copy has not yet been sent to the International Bureau, the receiving Office shall transmit the said notice together with the record copy.

(b) If the search copy has already been sent to the International Searching Authority and the international application is withdrawn under Rule 90^{bis}.1 or a priority claim is withdrawn under Rule 90^{bis}.3, the receiving Office shall promptly transmit a copy of the notice effecting withdrawal to the International Searching Authority.

(c) If the search copy has not yet been sent to the International Searching Authority and the international application is withdrawn under Rule 90^{bis}.1, the receiving Office shall not send the search copy to the International Searching Authority and shall, subject to Section 322, refund the search fee to the applicant unless it has already been transferred to the International Searching Authority. If the search fee has already been transferred to the International Searching Authority, the receiving Office shall send a copy of the request and of the notice effecting withdrawal to that Authority.

(d) If the search copy has not yet been sent to the International Searching Authority and a priority claim is withdrawn under Rule 90^{bis}.3, the receiving Office shall transmit a copy of the notice effecting withdrawal to the International Searching Authority together with the search copy.

Section 327

Ex Officio Correction of Request by the Receiving Office

(a) Subject to paragraph (d), where the record copy has not yet been sent to the International Bureau and the request requires correction because it contains

ADMINISTRATIVE INSTRUCTIONS UNDER THE PCT

an inconsistency or a minor defect such as non-compliance with the requirement for indications under Section 115, the receiving Office may correct the request *ex officio*. If the receiving Office does so, it shall notify the applicant accordingly.

(b) When making a correction under paragraph (a), the receiving Office shall enter, in the margin, the letters "RO." Where any matter is to be deleted, the receiving Office shall enclose such matter within square brackets and shall draw a line between the square brackets while still leaving the deleted matter legible. Where any matter is to be replaced, both the first and second sentences of this paragraph shall apply.

(c) The receiving Office shall check the number of characters of the file reference, if any, and shall delete any characters beyond the number permitted by Section 109.

(d) The receiving Office shall not make any *ex officio* correction to declarations referred to in Rule 4.17 which are contained in the request.

Section 328

Notifications Concerning Representation

(a) Where a power of attorney or a document containing the revocation or renunciation of an appointment is submitted to the receiving Office and the record and search copies have already been transmitted, the receiving Office shall immediately notify the International Bureau and the International Searching Authority by sending them a copy of the power of attorney or document and request the International Bureau to record a change in the indications concerning the agent or common representative under Rule 92^{bis}.1(a)(ii).

(b) If the record copy and/or search copy have not yet been transmitted by the receiving Office, a copy of the power of attorney or document containing the revocation or renunciation of an appointment shall be transmitted by the receiving Office with the record copy and/or search copy.

Section 329

Correction of Indications Concerning the Applicant's Residence or Nationality

Where, in response to an invitation to correct a defect under Article 11 (1)(i), evidence is submitted

indicating to the satisfaction of the receiving Office that, in fact, the applicant had, on the date on which the international application was actually received, the right to file an international application with that receiving Office, the invitation shall be considered to be an invitation to correct a defect under Article 14 (1)(a)(ii) and Rule 4.5 in the prescribed indications concerning the applicant's residence and/or nationality, and the applicant may correct those indications accordingly. If such correction is made, no defect shall be considered to exist under Article 11 (1)(i).

Section 330

Transmittal of Record Copy Prevented or Delayed by National Security Prescriptions

(a) Where prescriptions concerning national security prevent the transmittal of the record copy by the receiving Office to the International Bureau under Rule 22.1(a), the receiving Office shall notify the applicant and the International Bureau accordingly.

(b) The notifications under paragraph (a) shall be sent before the expiration of 13 months from the priority date. Where the receiving Office believes that national security clearance is imminent, it may postpone the sending of the notifications, but shall send them before the expiration of 17 months from the priority date if no clearance has been given by that time.

Section 331

Receipt of Confirmation Copy

Where, subject to Rule 92.4, the receiving Office receives an international application by facsimile machine transmission and subsequently receives the original of that international application, it shall mark such original with the words "CONFIRMATION COPY" or their equivalent in the language of publication of the international application on the bottom of the first page of the request and on the first page of the description. The marking under Section 325 is not required in such a case. The international application as received by facsimile machine transmission shall constitute the record copy. The confirmation copy shall be transmitted to the International Bureau in addition to the record copy.

Section 332

Notification of Languages Accepted by the receiving Office under Rules 12.1(a) and (c) and 12.4(a)

(a) Each receiving Office shall notify the International Bureau of the language or languages which, having regard to Rule 12.1(b), it is prepared to accept under Rule 12.1(a) for the filing of international applications.

(b) Each receiving Office shall notify the International Bureau of any change to the information notified under paragraphs (a), (d) and (e). If the change means that

(i) the receiving Office is no longer prepared to accept the filing of international applications in a language that it had previously notified the International Bureau that it was prepared to accept; or

(ii) the receiving Office is no longer prepared to accept the translation of international applications into a language of publication that it had previously notified the International Bureau that it was prepared to accept; or

(iii) the receiving Office is no longer prepared to accept the filing of requests in a language that it had previously notified the International Bureau that it was prepared to accept,

the effective date of such change shall be two months after the date of publication of the notification of the change in the Gazette pursuant to Section 405 or such later date as may be determined by the receiving Office.

(c) Nothing in paragraph (a), (b), (d) or (e) prevents any receiving Office from accepting, in a particular case,

(i) the filing of an international application in a language that it has not notified the International Bureau that it is prepared to accept; or

(ii) the translation of an international application into a language of publication that it has not notified the International Bureau that it is prepared to accept; or

(iii) the filing of a request in a language that it has not notified the International Bureau that it is prepared to accept.

(d) Each receiving Office concerned shall notify the International Bureau of the language or lan-

guages which it is prepared to accept under Rule 12.4(a) for the translation of international applications into a language of publication.

(e) Each receiving Office shall notify the International Bureau of the language or languages which it is prepared to accept under Rule 12.1(c) for the filing of requests.

Section 333

Transmittal of International Application to the International Bureau as Receiving Office

(a) Where a national Office intends to proceed under Rule 19.4(b) having regard to Rule 19.4(a)(i) or (ii), it shall, if it requires payment of the fee referred to in Rule 19.4(b) and that fee has not already been paid, promptly invite the applicant to pay that fee within a time limit of 15 days from the date of the invitation.

(b) Where a national Office intends to proceed under Rule 19.4(b) having regard to Rule 19.4(a)(iii), it shall promptly request the International Bureau as receiving Office to agree to the transmittal of the international application. The International Bureau as receiving Office shall promptly respond to that request. If the International Bureau as receiving Office agrees to the transmittal, the national Office shall promptly invite the applicant:

(i) if the transmittal has not already been authorized by the applicant, to submit to that Office, within a time limit of 15 days from the date of the invitation, an authorization of the transmittal, and,

(ii) if the Office requires payment of the fee referred to in Rule 19.4(b) and that fee has not already been paid, to pay that fee within the time limit referred to in item (i).

(c) The national Office:

(i) need not proceed under Rule 19.4(b) having regard to Rule 19.4(a)(i) to (iii) if the Office requires payment of the fee referred to in Rule 19.4(b) and the applicant does not pay that fee;

(ii) shall not proceed under Rule 19.4(b) having regard to Rule 19.4(a)(iii) if the International Bureau as receiving Office does not agree to, or if the applicant does not authorize, the transmittal of the international application under Rule 19.4(a)(iii).

Section 334

Notification to Applicant of Submission of Demand After the Expiration of 19 Months from the Priority Date

Where the demand is submitted after the expiration of 19 months from the priority date to a receiving Office and the time limit under Article 22 (1), as in force from April 1 2002, does not apply in respect of all designated Offices, the receiving Office shall:

- (i) promptly notify the applicant accordingly, directing attention to the fact that the time limit under Article 39(1)(a) does not apply, and that Article 22(1), as in force until March 31, 2002, continues to apply in respect of any such designated Office, and
- (ii) proceed under Rule 59.3.

Section 335

Transmittal of PCT-EASY Diskette Containing Request Data and Abstract

Any PCT-EASY diskette furnished to the receiving Office in accordance with Section 102^{bis} shall be

transmitted by that Office to the International Bureau at the same time as the record copy.

Section 336

Waivers Under Rules 90.4(d) and 90.5(c)

(a) Where, in accordance with Rule 90.4(d), a receiving Office waives the requirement under Rule 90.4(b) that a separate power of attorney be submitted to it, the receiving Office shall notify the International Bureau accordingly.

(b) Where, in accordance with Rule 90.5(c), a receiving Office waives the requirement under Rule 90.5(a)(ii) that a copy of a general power of attorney be attached to the request or any separate notice, the receiving Office shall notify the International Bureau accordingly.

(c) A receiving Office may require a separate power of attorney, or a copy of a general power of attorney, in particular instances even if the receiving Office has waived the requirement in general.

(d) A receiving Office which has notified the International Bureau under paragraph (a) or (b) shall notify the International Bureau of any change to the information notified under those paragraphs.

PART 4

INSTRUCTIONS RELATING TO THE INTERNATIONAL BUREAU

Section 401

Marking of the Sheets of the Record Copy

(a) The International Bureau shall, upon receipt of the record copy, mark the date of receipt of the record copy in the appropriate space on the request.

(b) If the receiving Office has failed to mark any sheet as provided in Sections 311 and 325, the marking which has not been made may be inserted by the International Bureau.

Section 402

Correction or Addition of a Priority Claim Under Rule 26^{bis}

(a) Where the applicant, in a notice submitted to the International Bureau, corrects or adds a priority claim under Rule 26^{bis}, that Bureau shall enter the correction or addition in the request, draw a line through, while still leaving legible, any indication deleted as a result of the correction, and enter, in the margin, the letters "IB".

(b) [Deleted]

(c) The applicant, the receiving Office and the International Searching Authority shall be promptly notified by the International Bureau of any correction or addition of a priority claim under Rule 26^{bis} and of the date on which it received such correction or addition.

(d) [Deleted]

Section 403

Transmittal of Protest Against Payment of Additional Fee and Decision Thereon Where International Application Is Considered to Lack Unity of Invention

Where, under Rules 40.2(c) or 68.3(c), the International Bureau receives a request from the applicant to forward to any designated or elected Office the texts of both the protest against payment of an additional fee as provided for in Articles 17(3)(a) and 34(3)(a) where the international application is considered to lack unity of invention and the decision thereon by the

International Searching Authority or the International Preliminary Examining Authority, as the case may be, it shall proceed according to such request.

Section 404

International Publication Number of International Application

The International Bureau shall assign to each published international application an international publication number which shall be different from the international application number. The international publication number shall be used on the pamphlet and in the Gazette entry. It shall consist of the two-letter code "WO" followed by a four-digit indication of the year of publication, a slant, and a serial number consisting of six digits (e.g., "WO 2004/123456").

Section 405

Publication of Notifications of Languages Accepted by the receiving Office under Rules 12.1(a) and (c) and 12.4(a)

The International Bureau shall promptly publish in the Gazette any notification under Section 332(a), (b), (d), or (e).

Section 406

Pamphlets

(a) Pamphlets referred to in Rule 48.1 shall be published on a given day of the week.

(b) All pamphlets shall be of A4 size and shall be reproduced recto verso, except that drawings shall be reproduced recto only.

(c) The form and particulars of the front page of each pamphlet shall be decided by the Director General.

Section 407

The Gazette

(a) The Gazette in paper form referred to in Rule 86.1(b)(i) shall be of A4 size and shall be reproduced *recto verso*.

ADMINISTRATIVE INSTRUCTIONS UNDER THE PCT

(b) The Gazette in electronic form referred to in Rule 86.1 (b)(ii) shall be made available on the Internet, on CD-ROM and by any other electronic means as determined by the Director General. Details concerning the availability of the Gazette in electronic form shall be published in the Gazette in paper form.

(c) In addition to the contents specified in Rule 86, the Gazette shall contain, in respect of each published international application, the data indicated in Annex D.

(d) The information referred to in Rule 86.1(a)(v) shall be that which is indicated in Annex E.

Section 408

Priority Application Number

(a) [Deleted]

(b) If the number of the earlier application referred to in Rule 4.10(a)(ii) (“priority application number”) is furnished after the expiration of the prescribed time limit, the International Bureau shall inform the applicant and the designated Offices of the date on which the said number was furnished. It shall indicate the said date in the international publication by including on the front page of the pamphlet next to the priority application number the words “FURNISHED LATE ON... (date),” and the equivalent of such words in the language in which the international application is published if that language is other than English.

(c) If the priority application number has not been furnished at the time of the completion of the technical preparations for international publication, the International Bureau shall indicate that fact by including on the front page of the pamphlet in the space provided for the priority application number the words “NOT FURNISHED” and the equivalent of such words in the language in which the international application is published if that language is other than English.

Section 409

Priority Claim Considered Not To Have Been Made

Where the International Bureau declares, under Rule 26^{bis}.2(b), that a priority claim is considered not to have been made, that Bureau shall enclose the priority claim concerned within square brackets, draw a

line between the square brackets, while still leaving legible the indications concerned, and enter, in the margin, the words “NOT TO BE CONSIDERED FOR PCT PROCEDURE (IB)” or their equivalent in the language of publication of the international application, and shall notify the applicant accordingly. The International Bureau shall also notify the receiving Office and the International Searching Authority.

Section 410

Numbering of Sheets for the Purposes of International Publication; Procedure in Case of Missing Sheets or Drawings

(a) In the course of preparing the international application for international publication, the International Bureau shall sequentially renumber the sheets to be published only when necessitated by the addition of any new sheet, the deletion of entire sheets or a change in the order of the sheets. Otherwise, the numbering provided under Section 207 shall be maintained.

(b) Where a sheet or a drawing has not been filed or is not to be taken into consideration for the purposes of international processing under Section 309(c) or Section 310(d), the International Bureau shall include an indication to that effect in the pamphlet.

Section 411

Receipt of Priority Document

(a) The International Bureau shall mark, on the first page of the priority document:

(i) the date on which the priority document has been received by it, and

(ii) the words “PRIORITY DOCUMENT—SUBMITTED OR TRANSMITTED IN COMPLIANCE WITH RULE 17.1(a) OR (b)” or the words “PRIORITY DOCUMENT — SUBMITTED OR TRANSMITTED BUT NOT IN COMPLIANCE WITH RULE 17.1(a) OR (b),” as applicable, or their equivalent in French, and shall notify the applicant and, preferably together with the notification under Rule 47.1(a^{bis}), the designated Offices, accordingly.

(b) Where the priority document has been submitted or transmitted but not in compliance with Rule 17.1(a) or (b), the International Bureau shall, in the notification under paragraph (a) of this Section, direct

the attention of the applicant and the designated Offices to the provisions of Rule 17.1(c).

Section 412

Notification of Lack of Transmittal of Search Copy

If the International Bureau does not receive from the International Searching Authority a notification under Rule 25.1 within two months from the date of receipt of the record copy, the International Bureau shall remind the receiving Office to transmit the search copy to the International Searching Authority. A copy of the reminder shall be sent to the International Searching Authority.

Section 413

Corrections of Defects Under Rule 26.4, Rectifications of Obvious Errors Under Rule 91.1, and Corrections Under Rule 9.2

(a) Where the International Bureau receives from the receiving Office a letter containing a correction of any defects under Rule 26.4, or a replacement sheet and the letter accompanying it, the International Bureau shall transfer the correction to the record copy, together with the indication of the date on which the receiving Office received the letter, or shall insert the replacement sheet in the record copy. Any letter and any replaced sheet shall be kept in the file of the international application.

(b) Paragraph (a) shall apply *mutatis mutandis* to rectifications of obvious errors authorized by the receiving Office or by the International Searching Authority under Rule 91.1 and to corrections submitted by the applicant to the receiving Office or the International Searching Authority aimed at complying with the prescription of Rule 9.1 concerning certain expressions, drawings, statements or other matter.

Section 414

Notification to the International Preliminary Examining Authority Where the International Application is Considered Withdrawn

If a demand has been submitted and the international application is considered withdrawn under Article 14(1), (3) or (4), the International Bureau shall promptly notify the International Preliminary Exam-

ining Authority, unless the international preliminary examination report has already issued.

Section 415

Notification of Withdrawal Under Rule 90^{bis}.1, 90^{bis}.2, 90^{bis}.3 or 90^{bis}.4

(a) The fact of withdrawal by the applicant of the international application under Rule 90^{bis}.1, of designations under Rule 90^{bis}.2, or of a priority claim under Rule 90^{bis}.3, together with the date on which the notice effecting withdrawal reached the International Bureau, the International Preliminary Examining Authority or the receiving Office, shall be recorded by the International Bureau and promptly notified by it to the receiving Office, the applicant, the designated Offices affected by the withdrawal and, where the withdrawal concerns the international application or a priority claim and where the international search report, or the declaration referred to in Article 17(2)(a), and the written opinion of the International Searching Authority have not yet issued, the International Searching Authority. However, where the withdrawal concerns the international application and where the notice effecting withdrawal was filed with the receiving Office before the sending of the record copy to the International Bureau, that Bureau shall send the notifications referred to in the preceding sentence and in Rule 24.2(a) to the receiving Office and the applicant only.

(b) If, at the time of the withdrawal of the international application under Rule 90^{bis}.1, or of a priority claim under Rule 90^{bis}.3, a demand has already been submitted and the international preliminary examination report has not yet issued, the International Bureau shall, unless the notice effecting withdrawal was submitted to the International Preliminary Examining Authority, promptly notify the fact of withdrawal to that Authority, together with the date on which the notice effecting withdrawal has reached the International Bureau or the receiving Office.

(c) The fact of withdrawal by the applicant of the demand or of one or more elections under Rule 90^{bis}.4, together with the date on which the notice effecting withdrawal was, or was considered to have been, submitted to the International Bureau, shall be promptly notified by that Bureau:

ADMINISTRATIVE INSTRUCTIONS UNDER THE PCT

- (i) to the applicant,
- (ii) to each elected Office affected by the withdrawal, except where it has not yet been notified of its election, and
- (iii) in the case of withdrawal of the demand or of all elections, to the International Preliminary Examining Authority, unless the notice effecting withdrawal was submitted to that Authority.

Section 416

Correction of Request in Record Copy

(a) Where the request requires correction as a consequence of the withdrawal of a designation or of a change made under Rule 92^{bis}, the International Bureau shall make the necessary correction in the record copy and shall notify the applicant and the receiving Office accordingly.

(b) When making a correction under paragraph (a), the International Bureau shall enter, in the margin, the letters “IB.” Where the correction involves the deletion or replacement of some matter, the International Bureau shall enclose such matter within square brackets and shall draw a line between the square brackets while still leaving the deleted or replaced matter legible.

Section 417

Processing of Amendments Under Article 19

(a) The International Bureau shall record the date on which, under Rule 46.1, any amendment made under Article 19 was received, shall notify the applicant of that date and indicate it in any publication or copy issued by it.

(b) The International Bureau shall mark, in the upper right-hand corner of each replacement sheet submitted under Rule 46.5(a), the international application number, the date on which that sheet was received under Rule 46.1 and, in the middle of the bottom margin, the words “AMENDED SHEET (ARTICLE 19).” It shall keep in its files any replaced sheet, the letter accompanying the replacement sheet or sheets, and any letter referred to in the last sentence of Rule 46.5(a).

(c) The International Bureau shall insert any replacement sheet in the record copy and, in the case referred to in the last sentence of Rule 46.5(a), shall indicate the cancellations in the record copy.

(d) If, at the time when the demand is received by the International Bureau, the international search report and the written opinion of the International Searching Authority have been established and no amendments under Article 19 have been made, the International Bureau shall inform the International Preliminary Examining Authority accordingly, unless the Authority has informed the International Bureau that it wishes not to be so notified.

Section 418

Notifications to Elected Offices Where the Demand Is Considered Not to Have Been Submitted or Made

Where, after any elected Office has been notified of its election under Article 31(7), the demand is considered not to have been submitted or made, the International Bureau shall notify the said Office accordingly.

Section 419

Processing of a Declaration Under Rule 26^{ter}

(a) Where any declaration referred to in Rule 4.17, or any correction thereof under Rule 26^{ter}.1, is submitted to the International Bureau within the time limit under Rule 26^{ter}.1, the International Bureau shall indicate the date on which it received the declaration or correction and insert the additional sheet or replacement sheet in the record copy.

(b) The International Bureau shall promptly notify the applicant, the receiving Office and the International Searching Authority of any declaration corrected or added under Rule 26^{ter}.1.

(c) The International Bureau shall not make any *ex officio* correction to declarations referred to in Rule 4.17 which are contained in the request.

(d) Where any declaration referred to in Rule 4.17, or any correction thereof under Rule 26^{ter}.1, is submitted to the International Bureau after the expiration of the time limit under Rule 26^{ter}.1, the International Bureau shall notify the applicant accordingly and inform the applicant that such a declaration or correction should be submitted directly to the designated Office or Offices concerned. Any declaration referred to in Rule 4.17(iv), signed as prescribed in Section 214, which is submitted to the International

Bureau after the expiration of the time limit under Rule 26^{ter}.1 shall be returned to the applicant.

Section 420

Copy of International Application and International Search Report for the International Preliminary Examining Authority

Where the International Preliminary Examining Authority is not part of the same national Office or intergovernmental organization as the International Searching Authority, the International Bureau shall, promptly upon receipt of the international search report or, if the demand was received after the international search report, promptly upon receipt of the demand, send a copy of the international application and the international search report to the International Preliminary Examining Authority. In cases where, instead of the international search report, a declaration under Article 17(2)(a) was issued, references in the preceding sentence to the international search report shall be considered references to the said declaration.

Section 421

Invitation to Furnish a Copy of the Priority Document

Where a request for a copy of the application whose priority is claimed in the international application is made under Rule 43^{bis}.1(b) by the International Searching Authority or, under Rule 66.7(a), by either the International Searching Authority, or the International Preliminary Examining Authority before the International Bureau has received the priority document under Rule 17.1, the International Bureau shall, unless the applicable time limit referred to in Rule 17.1(a) has already expired, inform the applicant of such request and remind him of the requirements of Rule 17.1.

Section 422

Notifications Concerning Changes Recorded Under Rule 92^{bis}.1

(a) The International Bureau shall give notifications concerning changes recorded by it under Rule 92^{bis}.1(a), except changes which are the subject of notifications under Section 425:

- (i) to the receiving Office;

- (ii) as long as the international search report, or the declaration referred to in Article 17(2)(a), and the written opinion of the International Searching Authority have not been established, to the International Searching Authority;

- (iii) to the designated Offices unless the change can be duly reflected in the pamphlet used for the purposes of the communication of the international application under Article 20;

- (iv) as long as the international preliminary examination report has not been established, to the International Preliminary Examining Authority;

- (v) to the elected Offices, unless the change can be duly reflected in the pamphlet used for the purposes of the communication of the international application under Article 20;

- (vi) to the applicant; where the change consists of a change in the person of the applicant, the notification shall be sent to the earlier applicant and the new applicant, provided that, where the earlier applicant and the new applicant are represented by the same agent, one notification only shall be sent to the said agent.

- (b) Where Rule 92^{bis}.1(b) applies, the International Bureau shall notify the applicant accordingly and, if the change was requested by the receiving Office, that Office.

Section 422^{bis}

Objections Concerning Changes in the Person of the Applicant Recorded Under Rule 92^{bis}.1(a)

(a) Where a change recorded by the International Bureau under Rule 92^{bis}.1(a):

- (i) consists of a change in the person of the applicant, and

- (ii) the request under Rule 92^{bis}.1(a) was not signed by or on behalf of both the earlier and the new applicant, and

- (iii) the earlier applicant objects to the change in writing,

the change under Rule 92^{bis}.1(a) shall be considered as if it had not been recorded.

- (b) Where paragraph (a) applies, the International Bureau shall notify all those who received a notification under Section 422(a) accordingly.

Section 423

Cancellation of Designations and Elections

(a) The International Bureau shall, if the receiving Office has failed to do so, cancel *ex officio* the designation of any State which is not a Contracting State, shall enclose that designation within square brackets, draw a line between the square brackets while still leaving the designation legible, enter, in the margin, the words “CANCELLED EX OFFICIO BY IB” or their equivalent in French, and notify the applicant and the receiving Office accordingly.

(b) The International Bureau shall cancel *ex officio*:

(i) the election of any State which is not a designated State;

(ii) the election of any State not bound by Chapter II of the Treaty, if the International Preliminary Examining Authority has failed to do so.

(c) The International Bureau shall enclose the cancelled election within square brackets, draw a line between the square brackets while still leaving the election legible, enter, in the margin, the words “CANCELLED EX OFFICIO BY IB” or their equivalent in French, and notify the applicant and, if the election is in the demand, the International Preliminary Examining Authority accordingly.

Section 424

[Deleted]

Section 425

Notifications Concerning Representation

Where a power of attorney or a document containing the revocation or renunciation of an appointment is submitted to the International Bureau, the International Bureau shall immediately notify the receiving Office, the International Searching Authority and the International Preliminary Examining Authority by sending them a copy of the power of attorney or document and shall record a change in the indications concerning the agent or common representative under Rule 92^{bis}. In the case of a renunciation of an appointment, the International Bureau shall also notify the applicant. Where the International Bureau receives a notification concerning representation under Section

328, it shall immediately notify the International Preliminary Examining Authority accordingly.

Section 426

[Deleted]

Section 427

[Deleted]

Section 428

[Deleted]

Section 429

[Deleted]

Section 430

Notification of Designations under Rule 32

Where the effects of any international application are extended to a successor State under Rule 32.1(a), the International Bureau shall promptly, but not before the international publication of the international application, effect the communication under Article 20 to the designated Office concerned, and notify that Office under Rule 47.1(a^{bis})

Section 431

Publication of Notice of Submission of Demand

(a) For international applications in respect of which a demand is filed before January 1, 2004, the publication in the Gazette of information on the demand and the elected States concerned, as referred to in Rule 61.4, as in force until December 31, 2003, shall consist of a notice indicating that a demand has been submitted prior to the expiration of 19 months from the priority date and, as applicable, indicating that all eligible States have been elected or, where not all eligible States have been elected, indicating those eligible States which have not been elected.

(b) For international applications in respect of which a demand is filed on or after January 1, 2004, the publication in the Gazette of information on the demand and the elected States concerned, as referred to in Rule 61.4, as in force from January 1, 2004, shall consist of a notice indicating that a demand has been submitted prior to the expiration of the applicable time limit under Rule 54^{bis}.1(a) and that all Contract-

ing States which were designated and were bound by Chapter II of the Treaty have been elected. Where the demand is made subsequent to the expiration of 19 months from the priority date and the time limit under Article 22(1), as in force from April 1, 2002, does not apply in respect of all designated Offices, the notice shall also indicate that fact.

Section 432

Notification to Applicant of Submission of Demand After the Expiration of 19 Months from the Priority Date

Where the demand is submitted after the expiration of 19 months from the priority date and subsequently transmitted to the International Bureau under Rule 59.3(a), or is submitted after the expiration of 19 months from the priority date to the International Bureau, and the time limit under Article 22(1), as in force from April 1, 2002, does not apply in respect of all designated Offices, the International Bureau shall, together with the notification sent to the applicant under Rule 59.3(c)(i) or the invitation sent to the applicant under Rule 59.3(c)(ii), as the case may be:

(i) promptly notify the applicant accordingly, directing attention to the fact that the time limit under Article 39(1)(a) does not apply, and that Article 22(1), as in force until March 31, 2002, continues to apply in respect of any such designated Office,

(ii) proceed under Rule 59.3.

Section 433

Waivers Under Rules 90.4(d) and 90.5(c)

(a) Where, in accordance with Rule 90.4(d), the International Bureau waives the requirement under

Rule 90.4(b) that a separate power of attorney be submitted to it, the International Bureau shall publish a notice of this fact in the Gazette.

(b) The International Bureau may require a separate power of attorney in particular instances even if the International Bureau has waived the requirement in general.

Section 434

Publication of Information Concerning Waivers Under 90.4(d) and 90.5(c)

(a) Any waivers of the requirement under Rule 90.4(b) that a separate power of attorney be submitted, or any changes to the information, notified to the International Bureau under Sections 336(a), 517(a), or 617(a) shall be promptly published in the Gazette. The effective date of any change shall be two months after the date of publication of the change in the Gazette, or such later date as may be determined by the International Bureau.

(b) Any waivers of the requirement under Rule 90.5(a)(ii) that a copy of a general power of attorney be attached to the request, the demand or any separate notice, or any changes to the information, notified to the International Bureau under Sections 336(b), 517(b), or 617(b) shall be promptly published in the Gazette. The effective date of any change shall be two months after the date of publication of the change in the Gazette, or such later date as may be determined by the International Bureau.

PART 5

INSTRUCTIONS RELATING TO THE INTERNATIONAL SEARCHING AUTHORITY

Section 501

Corrections Submitted to the International Searching Authority Concerning Expressions, etc., Not To Be Used in the International Application

Where the International Searching Authority receives corrections aimed at complying with Rule 9.1, Section 511 shall apply *mutatis mutandis*, provided that, where a sheet is marked as indicated in Section 511(a)(ii), the words “SUBSTITUTE SHEET (RULE 9.2)” shall be used.

Section 502

Transmittal of Protest Against Payment of Additional Fee and Decision Thereon Where International Application Is Considered to Lack Unity of Invention

The International Searching Authority shall transmit to the applicant, preferably at the latest together with the international search report, any decision which it has taken under Rule 40.2(c) on the protest of the applicant against payment of an additional fee where the international application is considered to lack unity of invention. At the same time, it shall transmit to the International Bureau a copy of both the protest and the decision thereon, as well as any request by the applicant to forward the texts of both the protest and the decision thereon to the designated Offices.

Section 503

Method of Identifying Documents Cited in the International Search Report and the Written Opinion of the International Searching Authority

Identification of any document cited in the international search report shall be as provided in WIPO Standard ST.14 (Recommendation for the Inclusion of References Cited in Patent Documents).⁴ Any doc-

ument cited in the international search report may be referred to in a shortened form in the written opinion of the International Searching Authority, provided that the reference to the document is unambiguous.

Section 504

Classification of the Subject Matter of the International Application

(a) Where the subject matter of the international application is such that classification thereof requires more than one classification symbol according to the principles to be followed in the application of the International Patent Classification to any given patent document, the international search report shall indicate all such symbols.

(b) Where any national classification system is used, the international search report may indicate all the applicable classification symbols also according to that system.

(c) Where the subject matter of the international application is classified both according to the International Patent Classification and to any national classification system, the international search report shall, wherever possible, indicate the corresponding symbols of both classifications opposite each other.

(d) The version of the International Patent Classification applicable at the time the international application is published under Article 21 shall be used whenever feasible.

Section 505

Indication of Citations of Particular Relevance in the International Search Report

(a) Where any document cited in the international search report is of particular relevance, the special indication required by Rule 43.5(c) shall consist of the letter(s) “X” and/or “Y” placed next to the citation of the said document.

⁴Editor’s Note: Published in the *WIPO Handbook on Industrial Property Information and Documentation*.

(b) Category “X” is applicable where a document is such that when taken alone, a claimed invention cannot be considered novel or cannot be considered to involve an inventive step.

(c) Category “Y” is applicable where a document is such that a claimed invention cannot be considered to involve an inventive step when the document is combined with one or more other such documents, such combination being obvious to a person skilled in the art.

Section 506

[Deleted]

Section 507

Manner of Indicating Certain Special Categories of Documents Cited in the International Search Report

(a) Where any document cited in the international search report refers to an oral disclosure, use, exhibition, or other means referred to in Rule 33.1(b), the separate indication required by that Rule shall consist of the letter “O” placed next to the citation of the said document.

(b) Where any document cited in the international search report is a published application or patent as defined in Rule 33.1(c), the special mention required by that Rule shall consist of the letter “E” placed next to the citation of the said document.

(c) Where any document cited in the international search report is not considered to be of particular relevance requiring the use of categories “X” and/or “Y” as provided in Section 505 but defines the general state of the art, it shall be indicated by the letter “A” placed next to the citation of the said document.⁵

(d) Where any document cited in the international search report is a document whose publication date occurred earlier than the international filing date of the international application, but later than the priority date claimed in that application, it shall be indi-

cated by the letter “P” next to the citation of the said document.

(e) Where any document cited in the international search report is a document whose publication date occurred after the filing date or the priority date of the international application and is not in conflict with the said application, but is cited for the principle or theory underlying the invention, which may be useful for a better understanding of the invention, or is cited to show that the reasoning or the facts underlying the invention are incorrect, it shall be indicated by the letter “T” next to the citation of the document.

(f) Where in the international search report any document is cited for reasons other than those referred to in paragraphs (a) to (e), for example:

— a document which may throw doubt on a priority claim,⁶

— a document cited to establish the publication date of another citation,⁷

such document shall be indicated by the letter “L” next to the citation of the document and the reason for citing the document shall be given.

(g) Where a document is a member of a patent family,⁸ it shall, whenever feasible, be mentioned in the international search report in addition to the one cited belonging as well to this family and should be preceded by the sign ampersand (&). Members of a patent family may also be mentioned on a separate sheet, provided that the family to which they belong shall be clearly identified and that any text matter on that sheet, if not in the English language, shall also be furnished to the International Bureau in English translation.

(h) A document whose contents have not been verified by the search examiner but are believed to be substantially identical with those of another document which the search examiner has inspected, may be cited in the international search report in the manner indicated for patent family members in the first sentence of paragraph (g).⁹

⁵See Chapter III, paragraph 3.14 of the PCT Search Guidelines.

⁶See Chapter VI, paragraph 4.3 of the PCT Search Guidelines.

⁷See Chapter VI, paragraph 6.2 of the PCT Search Guidelines.

⁸See Chapter IV, paragraph 3.2 of the PCT Search Guidelines.

⁹See Chapter VI, paragraph 5.2 of the PCT Search Guidelines.

Section 508

Manner of Indicating the Claims to Which the Documents Cited in the International Search Report Are Relevant

(a) The claims to which cited documents are relevant shall be indicated by placing in the appropriate column of the international search report:

(i) where the cited document is relevant to one claim, the number of that claim; for example, “2” or “17”;

(ii) where the cited document is relevant to two or more claims numbered in consecutive order, the number of the first and last claims of the series connected by a hyphen; for example, “1-15” or “2-3”;

(iii) where the cited document is relevant to two or more claims that are not numbered in consecutive order, the number of each claim placed in ascending order and separated by a comma or commas; for example, “1, 6” or “1, 7, 10”;

(iv) where the cited document is relevant to more than one series of claims under (ii), above, or to claims of both categories (ii) and (iii), above, the series or individual claim numbers and series placed in ascending order using commas to separate the several series, or to separate the numbers of individual claims and each series of claims; for example, “1-6, 9-10, 12-15” or “1, 3-4, 6, 9-11.”

(b) Where different categories apply to the same document cited in an international search report in respect of different claims or groups of claims, each relevant claim or group of claims shall be listed separately opposite each indicated category of relevance. Each category and each relevant claim or group of claims may be separated by a line.

The following example illustrates the situation where a document is of particular relevance under Section 505(b) as to claims 1 to 3 and under Section 505(c) as to claim 4, and indicates the general state of the art under Section 507(c) as to claims 11 and 12:

<i>Category</i>	<i>Citation</i>	<i>Relevant to claim No.</i>
	GB, A 392,415 (JONES) 18 May 1933 (18.05.33)	
X	Fig.1	1-3
Y	page 3, lines 5-7	4
A	Fig.5, support 36	11-12

Section 509

International Search and Written Opinion of the International Searching Authority on the Basis of a Translation of the International Application

Where the International Searching Authority has carried out the international search and established the written opinion on the basis of a translation of the international application transmitted to that Authority under Rule 23.1(b), the international search report and the written opinion of the International Searching Authority shall so indicate.

Section 510

Refund of Search Fee in Case of Withdrawal of International Application

(a) Where the international application is withdrawn or is considered withdrawn before the International Searching Authority has started the international search, that Authority shall, subject to paragraphs (b) and (c), refund the search fee to the applicant.

(b) If the refund referred to in paragraph (a) is not compatible with the national law of the national Office acting as International Searching Authority and as long as it continues to be not compatible with that law, the International Searching Authority may abstain from refunding the search fee.

(c) The International Searching Authority may, before making a refund under paragraph (a), first invite the applicant to submit a request for the refund.

Section 511

Rectifications of Obvious Errors Under Rule 91.1

(a) Where the International Searching Authority authorizes a rectification under Rule 91.1, it shall:

(i) indelibly mark, in the upper right-hand corner of each replacement sheet, the international application number and the date on which that sheet was received;

(ii) indelibly mark, in the middle of the bottom margin of each replacement sheet, the words "RECTIFIED SHEET (RULE 91)" or their equivalent in the language of publication of the international application as well as an indication of the International Searching Authority as provided for in Section 107(b);

(iii) indelibly mark on the letter containing the rectification or accompanying any replacement sheet the date on which that letter was received;

(iv) keep in its files a copy of the letter containing the rectification or, when the rectification is contained in a replacement sheet, the replaced sheet, a copy of the letter accompanying the replacement sheet, and a copy of the replacement sheet;

(v) promptly transmit any letter and any replacement sheet to the International Bureau and a copy thereof to the receiving Office.

(b) Where the International Searching Authority refuses to authorize a rectification under Rule 91.1, it shall proceed as indicated under paragraph (a)(i), (iii), and (iv) and promptly transmit any letter and any proposed replacement sheet to the International Bureau.

Section 512

Notifications Concerning Representation

Where a power of attorney or a document containing the revocation or renunciation of an appointment is submitted to the International Searching Authority, that Authority shall immediately notify the International Bureau by sending it a copy of the power of attorney or document and request the International Bureau to record a change in the indications concerning the agent or common representative under Rule 92^{bis}.1 (a)(ii).

Section 513

Sequence Listings

(a) Where the International Searching Authority receives a correction of a defect under Rule 13^{ter}.1(d), it shall:

(i) indelibly mark, in the upper right-hand corner of each replacement sheet, the international application number and the date on which that sheet was received;

(ii) indelibly mark, in the middle of the bottom margin of each replacement sheet, the words "SUBSTITUTE SHEET (RULE 13^{ter}.1(d))" or their equivalent in the language of publication of the international application;

(iii) indelibly mark on the letter containing the correction, or accompanying any replacement sheet, the date on which that letter was received;

(iv) keep in its files a copy of the letter containing the correction or, when the correction is contained in a replacement sheet, the replaced sheet, a copy of the letter accompanying the replacement sheet, and a copy of the replacement sheet;

(v) promptly transmit any letter and any replacement sheet to the International Bureau, and a copy thereof to the receiving Office.

(b) Where the international search report and the written opinion of the International Searching Authority are based on a sequence listing that was not contained in the international application as filed but was furnished subsequently to the International Searching Authority, the international search report and the written opinion of the International Searching Authority shall so indicate.

(c) Where a meaningful international search cannot be carried out and a meaningful written opinion, as to whether the claimed invention appears to be novel, to involve an inventive step (to be non-obvious) and to be industrially applicable, cannot be established because a sequence listing is not available to the International Searching Authority in the required form, that Authority shall so state in the international search report or declaration referred to in Article 17(2)(a), and in the written opinion.

(d) The International Searching Authority shall indelibly mark, in the upper right-hand corner of the first sheet of any sequence listing in printed form which was not contained in the international

ADMINISTRATIVE INSTRUCTIONS UNDER THE PCT

application as filed but was furnished subsequently to that Authority, the words “SUBSEQUENTLY FURNISHED SEQUENCE LISTING” or their equivalent in the language of publication of the international application.

(e) The International Searching Authority shall keep in its files:

(i) any sequence listing in printed form which was not contained in the international application as filed but was furnished subsequently to that Authority; and

(ii) any sequence listing in computer readable form.

Section 514

Authorized Officer

The officer of the International Searching Authority responsible for the international search report, as referred to in Rule 43.8, and for the written opinion of the International Searching Authority, as referred to in Rule 43^{bis}.1(b), means the person who actually performed the search work and prepared the search report and the written opinion of the International Searching Authority, or another person who was responsible for supervising the search and the establishment of the written opinion.

Section 515

Amendment of Established Abstract in Response to Applicant's Comments

The International Searching Authority shall inform the applicant and the International Bureau of any amendments made under Rule 38.2(b) to an abstract established by it under Rule 38.2(a).

Section 516

Notification to Applicant of Submission of Demand After the Expiration of 19 Months from the Priority Date

Where the demand is submitted after the expiration of 19 months from the priority date to an International Searching Authority and the time limit under Article

22(1), as in force from April 1, 2002, does not apply in respect of all designated Offices, that Authority shall:

(i) promptly notify the applicant accordingly, directing attention to the fact that the time limit under Article 39(1)(a) does not apply, and that Article 22(1), as in force until March 31, 2002, continues to apply in respect of any such designated Office,

(ii) proceed under Rule 59.3.

Section 517

Waivers Under Rule 90.4(d) and Rule 90.5(c)

(a) Where, in accordance with Rule 90.4(d), an International Searching Authority waives the requirement under Rule 90.4(b) that a separate power of attorney be submitted to it, the International Searching Authority shall notify the International Bureau accordingly.

(b) Where, in accordance with Rule 90.5(c), an International Searching Authority waives the requirement under Rule 90.5(a)(ii) that a copy of a general power of attorney be attached to any separate notice, it shall notify the International Bureau accordingly.

(c) An International Searching Authority may require a separate power of attorney, or a copy of a general power of attorney, in particular instances even if the International Searching Authority has waived the requirement in general.

(d) An International Searching Authority which has notified the International Bureau under paragraph (a) or (b) shall notify the International Bureau of any change to the information notified under those paragraphs.

Section 518

Guidelines for Explanations Contained in the Written opinion of the International Searching Authority

For the purposes of establishing the written opinion of the International Searching Authority, Section 604 shall apply *mutatis mutandis*.

PART 6

INSTRUCTIONS RELATING TO THE INTERNATIONAL PRELIMINARY EXAMINING AUTHORITY

Section 601

Notification to Applicant of Submission of Demand After the Expiration of 19 Months from the Priority Date

(a) Where the demand is submitted after the expiration of 19 months from the priority date and the time limit under Article 22(1), as in force from April 1, 2002, does not apply in respect of all designated Offices, the International Preliminary Examining Authority shall promptly notify the applicant accordingly, directing attention to the fact that the time limit under Article 39(1)(a) does not apply, and that Article 22(1), as in force until March 31, 2002, continues to apply in respect of any such designated Office.

(b) Where the demand is submitted after the expiration of 19 months from the priority date to an International Preliminary Examining Authority which is not competent for the international preliminary examination of the international application, and the time limit under Article 22(1), as in force from April 1, 2002, does not apply in respect of all designated Offices, that Authority shall:

(i) promptly notify the applicant accordingly, directing attention to the fact that the time limit under Article 39(1)(a) does not apply, and that Article 22(1), as in force until March 31, 2002, continues to apply in respect of any such designated Office,

(ii) proceed under Rule 59.3.

Section 602

Processing of Amendments by the International Preliminary Examining Authority

(a) The International Preliminary Examining Authority shall:

(i) indelibly mark, in the upper right-hand corner of each replacement sheet submitted under Rule 66.8, the international application number and the date on which that sheet was received;

(ii) indelibly mark, in the middle of the bottom margin of each replacement sheet, the words "AMENDED SHEET" or their equivalent in the lan-

guage of the demand as well as an indication of the International Preliminary Examining Authority as provided for in Section 107(b);

(iii) subject to item (iv), keep in its files any replaced sheet, the letter accompanying any replacement sheet, and any superseded replacement sheet or any letter referred to in the last sentence of Rule 66.8(b) as well as a copy of any replacement sheet which is annexed to the international preliminary examination report;

(iv) where any superseded replacement sheet referred to in item (iii) is to be annexed to the international preliminary examination report under Rule 70.16(b), indelibly mark, in addition to the markings referred to in items (i) and (ii), in the middle of the bottom margin of each superseded replacement sheet, without obscuring the marking made under item (ii), the words "SUPERSEDED REPLACEMENT SHEET (RULE 70.16(b))";

(v) annex to the copy of the international preliminary examination report which is transmitted to the International Bureau any replacement sheet as provided for under Rule 70.16;

(vi) annex to the copy of the international preliminary examination report which is transmitted to the applicant a copy of each replacement sheet as provided for under Rule 70.16.

(b) Section 311(b)(ii) relating to the numbering of replacement sheets shall apply when one or more sheets are added under Rule 66.8.

(c) Where the International Preliminary Examining Authority receives from the applicant a copy of a purported amendment under Article 19 submitted after the time limit set forth in Rule 46.1, the International Preliminary Examining Authority may consider such an amendment as an amendment under Article 34 in which case it shall inform the applicant accordingly.

(d) Where the International Preliminary Examining Authority receives a copy of an amendment under Article 19, paragraphs (a) and (b) shall apply *mutatis mutandis*.

Section 603

Transmittal of Protest Against Payment of Additional Fee and Decision Thereon Where International Application Is Considered To Lack Unity of Invention

The International Preliminary Examining Authority shall transmit to the applicant, preferably at the latest together with the international preliminary examination report, any decision which it has taken under Rule 68.3(c) on the protest of the applicant against payment of an additional fee where the international application is considered to lack unity of invention. At the same time, it shall transmit to the International Bureau a copy of both the protest and the decision thereon, as well as any request by the applicant to forward the texts of both the protest and the decision thereon to the elected Offices.

Section 604

Guidelines for Explanations Contained in the International Preliminary Examination Report

(a) Explanations under Rule 70.8 shall clearly point out to which of the three criteria of novelty, inventive step (non-obviousness) and industrial applicability referred to in Article 35(2), taken separately, any cited document is applicable and shall clearly describe, with reference to the cited documents, the reasons supporting the conclusion that any of the said criteria is or is not satisfied.

(b) Explanations under Article 35(2) shall be concise and preferably in the form of short sentences.

Section 605

File to Be Used for International Preliminary Examination

Where the International Preliminary Examining Authority is part of the same national Office or inter-governmental organization as the International Searching Authority, the same file shall serve the purposes of international search and international preliminary examination.

Section 606

Cancellation of Elections

(a) The International Preliminary Examining Authority shall cancel *ex officio*:

(i) the election of any State which is not a designated State;

(ii) the election of any State not bound by Chapter II of the Treaty.

(b) The International Preliminary Examining Authority shall enclose that election within square brackets, shall draw a line between the square brackets while still leaving the election legible and shall enter, in the margin, the words "CANCELLED EX OFFICIO BY IPEA" or their equivalent in the language of the demand, and shall notify the applicant accordingly.

Section 606^{bis}

[Deleted]

Section 607

Rectifications of Obvious Errors Under Rule 91.1

Where the International Preliminary Examining Authority authorizes a rectification of an obvious error under Rule 91.1, Rule 70.16 and Section 602(a) and (b) shall apply *mutatis mutandis*, provided that, where a sheet is marked as indicated in Section 602, the words "RECTIFIED SHEET (RULE 91)" shall be used.

Section 608

Notifications Concerning Representation

Where a power of attorney or a document containing the revocation or renunciation of an appointment is submitted to the International Preliminary Examining Authority, that Authority shall immediately notify the International Bureau by sending it a copy of the power of attorney or document and request the International Bureau to record a change in the indications concerning the agent or common representative under Rule 92^{bis}.1(a)(ii).

Section 609

**Withdrawal by Applicant Under Rule 90^{bis}. 1,
90^{bis}. 2, or 90^{bis}. 3**

The International Preliminary Examining Authority shall promptly transmit to the International Bureau any notice from the applicant effecting withdrawal of the international application under Rule 90^{bis}.1(b), of a designation under Rule 90^{bis}.2(d), or of a priority claim under Rule 90^{bis}.3(c) which has been filed with it. The International Preliminary Examining Authority shall mark the notice with the date on which it was received.

Section 610

[Deleted]

Section 611

**Method of Identification of Documents in the
International Preliminary Examination Report**

Any document cited in the international preliminary examination report which was not cited in the international search report shall be cited in the same form as required under Section 503 for international search reports. Any document cited in the international preliminary examination report which was previously cited in the international search report may be cited in a shortened form, provided that the reference to the document is unambiguous.

Section 612

Authorized Officer

The officer of the International Preliminary Examining Authority responsible for the international preliminary examination report, as referred to in Rule 70.14, means the person who actually performed the examination work and prepared the international preliminary examination report or another person who was responsible for supervising the examination.

Section 613

**Invitation to Submit a Request for Refund of Fees
under Rule 57.6 or 58.3**

The International Preliminary Examining Authority may, before making a refund under Rule 57.6 or 58.3,

first invite the applicant to submit a request for the refund.

Section 614

Evidence of Right to File Demand

Where a demand is considered as not having been made under Rule 61.1(b) by the International Preliminary Examining Authority because the applicant appeared, on the basis of the indication made in the demand, not to have the right to file a demand with that Authority under Rule 54 but evidence is submitted indicating to the satisfaction of the International Preliminary Examining Authority that in fact, an applicant had, on the date on which the demand was received, the right to file the demand with that Authority, the International Preliminary Examining Authority shall regard the requirements under Article 31 (2)(a) as having been fulfilled on the date of actual receipt of the demand.

Section 615

**Invitation to Pay Fees Before Date on Which They
Are Due**

If the International Preliminary Examining Authority finds, before the date on which they are due, that the handling fee or the international preliminary examination fee are lacking in whole or in part, it may invite the applicant to pay the missing amounts within the time limit under Rule 57.3 or 58.1(b), as the case may be.

Section 616

**International Preliminary Examination on the
Basis of a Translation of the International
Application**

Where the International Preliminary Examining Authority has carried out international preliminary examination on the basis of a translation of the international application furnished to that Authority under Rule 55.2(a) or, in the case referred to in Rule 55.2 (b), transmitted, under Rule 23.1(b), to the national Office or intergovernmental organization of which that Authority is part, the international preliminary examination report shall so indicate.

ADMINISTRATIVE INSTRUCTIONS UNDER THE PCT

Section 617

Waivers Under Rule 90.4(d) and 90.5(c)

(a) Where, in accordance with Rule 90.4(d), an International Preliminary Examining Authority waives the requirement under Rule 90.4(b) that a separate power of attorney be submitted to it, the International Preliminary Examining Authority shall notify the International Bureau accordingly.

(b) Where, in accordance with Rule 90.5(c), an International Preliminary Examining Authority waives the requirement under Rule 90.5(a)(ii) that a copy of a general power of attorney be attached to the

demand or any separate notice, it shall notify the International Bureau accordingly.

(c) An International Preliminary Examining Authority may require a separate power of attorney, or a copy of a general power of attorney, in particular instances even if the International Preliminary Examining Authority has waived the requirement in general.

(d) An International Preliminary Examining Authority which has notified the International Bureau under paragraph (a) or (b) shall notify the International Bureau of any change to the information notified under those paragraphs.

PART 7

INSTRUCTIONS RELATING TO THE ELECTRONIC FILING AND PROCESSING OF INTERNATIONAL APPLICATIONS

Section 701

Abbreviated Expressions

For the purposes of this Part and Annex F, unless the contrary clearly follows from the wording, the nature of the provision or the context:

(i) “electronic” technology includes that having electrical, digital, magnetic, optical or electromagnetic capabilities;

(ii) “electronic document format” means the presentation or arrangement of the information in a document in electronic form;¹⁰

(iii) “means of transmittal,” in connection with a document in electronic form, means the manner in which a document is transmitted, for example, by electronic means or physical means;¹¹

(iv) “electronic signature” means information in electronic form which is attached to, or logically associated with, an electronic document, which may be used to identify the signer and which indicates the signer’s approval of the content of the document;

(v) “basic common standard” means the basic common standard for electronic filing of international applications provided for in Annex F;¹²

(vi) words and expressions whose meanings are explained in Annex F have the same meanings in this Part.¹³

Section 702

International Applications Filed in Electronic Form

(a) The filing and processing of international applications filed in electronic form, as referred to in Rule 89^{bis}, shall be in accordance with this Part and Annex F.¹⁴

(b) Subject to this Part, an international application in electronic form shall not be denied legal effect merely because it is in electronic form.

(c) This Part and Annex F do not apply to an international application containing a sequence listing part which is filed in computer readable form under Section 801(a).¹⁵

¹⁰ See Annex F, section 3.

¹¹ See Annex F, section 5.

¹² See Annex F, Appendix III.

¹³ For example, “electronic package” (see Section 703(b)(iii) and Annex F, section 4), “wrapped and signed package” (see Section 705(a) and (b) and Annex F, section 4.2.1), and a number of terms used in Section 710.

¹⁴ The proposed modifications do not provide for the conversion of applications from paper form to electronic form or for the filing of applications partly on paper and partly in electronic form. Those matters will be dealt with in other proposed modifications of the Administrative Instructions. Although Rule 89^{bis} also enables the Administrative Instructions to provide for the filing and processing of international applications “by electronic means,” proposed Part 7 relates in the main to applications filed “in electronic form” except where otherwise specifically mentioned (as, for example, in Section 709(a)). While applications in electronic form may, of course, be filed by electronic means, Part 7 generally focuses on the form of the application rather than the means of filing. The Regulations already provide for the filing by electronic means of applications in paper form (see Rule 92.4).

ADMINISTRATIVE INSTRUCTIONS UNDER THE PCT

Section 703

Filing Requirements; Basic Common Standard

(a) An international application may, subject to this Part, be filed in electronic form if the receiving Office has notified the International Bureau in accordance with Rule 89^{bis}.1(d) that it is prepared to receive international applications in such form.¹⁶

(b) An international application filed in electronic form shall be:

(i) in an electronic document format that has been specified by the receiving Office¹⁷ in accordance with Annex F or that complies with the basic common standard;^{18, 19}

(ii) filed by a means of transmittal that has been specified by the receiving Office¹⁷ in accordance with Annex F or that complies with the basic common standard;^{20, 19}

(iii) in the form of an electronic package, appropriate to the means of transmittal, in accordance with Annex F or that complies with the basic common standard;²¹

(iv) prepared and filed using electronic filing software that has been specified by the receiving Office 17 in accordance with Annex F or that complies with the basic common standard;^{22, 19} and

(v) free of viruses and other forms of malicious logic in accordance with Annex F or that complies with the basic common standard.²³

¹⁵ For example, such a sequence listing is not subject to data format and packaging requirements under Annex F, and the basic fee is calculated under Section 803 rather than Section 707. An application containing a sequence listing may, however, be filed in (fully) electronic form under Part 7 rather than partly on paper and partly in computer readable form under Section 801(a), in which case the application would be subject to Part 7 and Annex F and not Part 8. It should be remembered that Section 801 and the other provisions of Part 8 were introduced to deal with an immediate problem, namely, that of extremely large applications which cannot be dealt with practically on paper. Those provisions will need to be reviewed when electronic filing and processing systems have been more fully implemented, at which stage it is expected that such applications will be dealt with under the more general provisions of Part 7. In the meantime, however, an applicant who wishes to have the advantage of the provisions of Part 8 will have to comply with Section 801; the request will need to be filed on paper and accompanied by a sequence listing in computer readable form.

¹⁶ This provision is included for the sake of clarity, although it is probably not strictly necessary in the light of Rule 89^{bis}.1(a), (d) and (e). This provision does not, of course, affect the need for the receiving Office to be competent under Rule 19 to receive the application.

¹⁷ The receiving Office must specify the electronic document format(s), means of transmittal and electronic filing software that it is prepared to accept (see Section 710(a)(i)). The specification may be of a particular format, means or software, or may be expressed in general terms.

¹⁸ See Section 701(ii), Annex F, section 3, and Appendix III, section 2(a) to (c).

¹⁹ Use of the basic common standard (see Section 701(v) and Annex F, Appendix III) is not mandatory for applicants, but the receiving Office must accept applications that comply with the basic common standard in addition to applications that comply with different requirements that the Office may have specified for the purposes of paragraph 703(b)(i), (ii) and (iv). The basic common standard itself does, however, provide for certain options to be exercised by receiving Offices. Note that the basic common standard provides for the use of PKI technology for packaging the international application documents (but see also footnote 21).

²⁰ See Section 701(iii), Annex F, section 5, and Appendix III, section 2(d) and (e). In the case of on-line filing, the means of transmittal encompasses the use of a transmission protocol. The use of the E-filing Interoperability Protocol is provided for in Annex F, section 5.1, and forms part of the basic common standard (see Appendix III, section 2(d)).

²¹ See Annex F, sections 4 and 5.2. For on-line filing, the options for electronic packaging under the present text of Annex F all provide for the use of PKI, although the proposal and adoption of other solutions in the future is not precluded.

²² See Annex F, section 6, and Appendix III, section 2(g). Electronic filing software to be developed by the International Bureau as an extension of the PCT-EASY software will be made available to applicants and receiving Offices. That software will support the basic common standard and certain alternatives available under Annex F. Use of that software would not be mandatory, but it will have to be accepted by any receiving Office under the basic common standard. That result is consistent with the conclusion of the Committee on Reform of the Patent Cooperation Treaty (PCT) reached at its first session in May 2001 (see document PCT/R/1/26, paragraph 66(x)). Any receiving Office will, however, also be able under Section 703(b)(iv) to specify other filing software acceptable to it.

²³ See Annex F, section 3.

(c) An international application filed in electronic form shall, for the purposes of Article 14(1)(a)(i), be signed by the applicant using a type of electronic signature that has been specified by the receiving Office in accordance with Annex F or, subject to Section 704(g), that complies with the basic common standard.^{24, 19}

(d) A receiving Office which has not notified the International Bureau in accordance with Rule 89.1(d) that it is prepared to receive international applications in electronic form may nevertheless decide in a particular case to receive an international application submitted to it in such form, in which case this Part shall apply accordingly.

(e) Any receiving Office may refuse to receive an international application submitted to it in electronic form if the application does not comply with paragraph (b), or may decide to receive the application.

(f) If, on 7 January 2002, the applicable national law and the technical systems of a national Office provide for the filing with it of national applications in electronic form according to requirements which are incompatible with any of items (ii) to (iv) of paragraph (b):²⁵

(i) the provisions concerned²⁶ shall not apply in respect of the Office in its capacity as a receiving Office for as long as the incompatibility continues; and

(ii) the Office may instead provide for the filing with it of international applications in electronic form according to that national law and those technical systems; provided that the Office informs the International Bureau accordingly by the date on which the Office sends the International Bureau a notification under Rule 89.1(d) and in any case no later than 7 April 2002. The information received shall be promptly published by the International Bureau in the Gazette.

Section 704

Receipt; International Filing Date; Signature; Physical Requirements; Subsequent Documents and Correspondence

(a) The receiving Office shall promptly²⁷ notify the applicant of, or otherwise enable the applicant to obtain confirmation of, the receipt of any purported international application filed with it in electronic form. The notification or confirmation shall indicate or contain:

(i) the identity of the Office;

²⁴ See Section 701(iv), Annex F, section 3.3, and Appendix III, section 2(i). The receiving Office must specify the type(s) of electronic signature that it is prepared to accept (see section 710(a)(i)). While signature in compliance with the basic common standard is sufficient for the purposes of filing, compliance with the receiving Office's particular requirements may be required subsequently pursuant to Section 704(g). Note the distinction between requirements as to signature of the application for the purposes of Article 14(1)(a)(i) (which may be a basic or enhanced electronic signature by the applicant) as distinct from packaging (which requires the use of the digital signature of the sender),

²⁵ It will not be possible to make a transitional reservation in respect of the requirements of Section 703(b)(i). In addition to complying with that Section, an Office that has made a transitional reservation under Section 703(f) would have to comply with other applicable provisions of Part 7 and Annex F. For example, Section 713(b) would require compliance with Annex F as to the electronic packaging of documents transmitted from the receiving Office to the International Bureau, that is, a PKI-based "SEP" or "WASP" package type would have to be used (see Annex F, sections 4 and 5.2.2). That would be the case even if the international application itself as filed with the receiving Office did not, pursuant to a transitional reservation by the Office under Section 703(f), comply with the requirements of Section 703(b)(iii) and Annex F, section 5.2.1, as to electronic packaging. Moreover, an applicant who filed an international application with a receiving Office which has made a transitional reservation under Section 703(f) as to the application of Section 703(b)(iii) would not have to comply with Annex F as to PKI-based electronic packaging of the application. However, any subsequent communications in electronic form between the applicant and the International Bureau, the International Searching Authority or the International Preliminary Examining Authority would have to comply with Annex F (see Annex F, sections 5.2.1 and 7.1).

²⁶ A transitional reservation under Section 703(f) may be expressed to apply in relation to all or only some of the provisions mentioned.

²⁷ Numbers of provisions in the Regulations and Administrative Instructions require "prompt" official action. The question of what is "prompt" in given circumstances is not defined in absolute terms but should be explained in the PCT Receiving Office Guidelines. In the context of Section 704(a), the notification should generally issue in minutes rather than hours or days. The various indications referred to in the Section may in some cases have to be notified or confirmed at different times, for example, in the case of batch submissions of documents.

ADMINISTRATIVE INSTRUCTIONS UNDER THE PCT

- (ii) the date of receipt;²⁸
- (iii) any reference number or application number assigned to the purported application by the Office; and
- (iv) a message digest, generated by the Office, of the purported application as received; and may, at the option of the Office, also indicate or contain other information such as:
 - (v) the names and sizes of the electronic files received;
 - (vi) the dates of creation of the electronic files received; and
 - (vii) a copy of the purported application as received.
- (b) Where the receiving Office refuses in accordance with Rule 89^{bis}.1(d) or Section 703(e) to receive a purported international application submitted to it in electronic form, it shall, if practicable having regard to the indications furnished by the applicant,²⁹ promptly notify the applicant accordingly.
- (c) Promptly after receiving a purported international application in electronic form, the receiving Office shall determine whether the purported application complies with the requirements of Article 11(1) and shall proceed accordingly.³⁰
- (d) Where an international application filed in electronic form is not signed in compliance with Section 703(c), the application shall be considered not to

comply with the requirements of Article 14(1)(a)(i) and the receiving Office shall proceed accordingly.

(e) Where an international application filed in electronic form does not comply with Section 703(b) but the receiving Office decides, under Section 703(e), to receive it, that non-compliance shall be considered to be non-compliance with the physical requirements referred to in Article 14(1)(a)(v) and the receiving Office shall proceed accordingly, having regard to whether compliance is necessary for the purpose of reasonably uniform international publication (Rule 26.3) and satisfactory electronic communications.³¹

(f) An international application filed in electronic form may, in accordance with the provisions of Rule 19.4, be transmitted by the Office with which the application was filed to the International Bureau as receiving Office.³²

(g) Where an international application filed in electronic form was signed using a type of electronic signature that complies with the basic common standard but that has not been specified by the receiving Office under Section 703(c), the Office may require that any subsequent document or correspondence submitted to it in electronic form be signed using a type of electronic signature that has been so specified.³³ If that requirement is not complied with, Rule 92.1(b) and (c) shall apply *mutatis mutandis*.

(h) The provisions of this Part, other than paragraph (g), shall apply *mutatis mutandis* to other docu-

²⁸ The date of receipt will be determined according to the usual principles applicable to the filing of applications on paper, including filing by electronic means (such as by facsimile transmission), that is, based on the date prevailing at the location of the Office at the time when the complete transmission of the application has been received.

²⁹ The receiving Office will, of course, be obliged to act reasonably in deciding what is “practicable” in the circumstances. While a filing date should be accorded wherever it is practicable to do so, it needs to be remembered that receiving Offices are not obliged to receive international applications which do not comply with Annex F (see Section 703(e)). Receiving Offices should not have to go to extreme lengths to find applicants who have not given adequate indications to enable them to be contacted.

³⁰ This provision, which repeats the substance of Rule 20.4(a), is included for the guidance of receiving Offices, although it is not strictly necessary in the light of Rules 89^{bis}.1(b).

³¹ The application of the criteria of “reasonably uniform international publication” and “satisfactory electronic communications” act as a restraint against overly strict enforcement of physical requirements by receiving Offices, similarly to Rule 26.3 which refers to “reasonably uniform international publication” and “satisfactory reproduction” in the case of applications filed on paper.

³² This provision is included for the guidance of receiving Offices, although it is not strictly necessary in the light of Rule 89.1(b). A receiving Office might wish to make use of Rule 19.4, for example, where an international application in electronic form is filed in a non-accepted format or by a non-accepted means. In the case referred to in Rule 19.4(a)(iii), the agreement of the Office and the International Bureau, and the authorization of the applicant, would be necessary. Note that the consequences of any non-compliance with national security requirements are a matter for national law and are not governed by either Rule 19.4 or Section 704(f); however, consideration will be given to including mention of such requirements in the PCT Receiving Office Guidelines.

ments and correspondence relating to international applications.³⁴

Section 705

Home Copy, Record Copy and Search Copy

(a) Where an international application is filed in electronic form as a wrapped and signed package in accordance with Annex F, the home copy and the record copy³⁵ in relation to that application for the purposes of Article 12 shall each consist of a copy in electronic form of that package.³⁶

(b) Where an international application is filed in electronic form but is not filed as a wrapped and signed package in accordance with Annex F, the home copy and the record copy in relation to that application for the purposes of Article 12 shall each consist of a copy in electronic form of the application as filed. If the application as filed was encrypted, the home copy and the record copy shall consist of the decrypted version. If the application as filed was infected by a virus or other form of malicious logic,

the home copy and the record copy shall consist of the disinfected version.³⁷

(c) Where the international application is filed in electronic form on a physical medium,³⁸ the home copy and the record copy shall not include the physical medium, but the receiving Office shall, for the purposes of Rule 93.1, retain the application as originally filed, together with the physical medium.³⁹

(d) Where the International Searching Authority has notified the International Bureau in accordance with Rule 89.1(d) that it is prepared to process international applications in electronic form, paragraphs (a) and (b) apply *mutatis mutandis* to the search copy; otherwise, the search copy shall consist of a copy of the application printed on paper by the receiving Office.

Section 706

Backup Copies⁴⁰

(a) Where an international application was filed in electronic form, the applicant may, if the receiving

³³ See Annex F, section 3.3. Under the basic common standard, an international application need only, for the purposes of the according of a filing date, be signed by the applicant using a basic electronic signature and packaged with the digital signature of the sender based on a low-level certificate. Under Section 704(g), the receiving Office, having accorded a filing date to such an application, would be entitled to require that subsequent documents and correspondence be signed by the applicant using a digital signature based on a high-level certificate. If that requirement is not complied with, Rule 92.1(b) and (c) shall apply *mutatis mutandis*.

³⁴ This provision makes it clear that the provisions of Part 7 relating to international applications also apply to other documents and correspondence. It appears to be necessary to include it in addition to Rule 89.2, which has the effect that Rule 89.1 applies to documents other than the international application, since Rule 89.1 is itself an enabling provision. Section 704(g) should not be covered by the provision since it makes special provisions for documents other than the international application.

³⁵ As in the case of applications filed on paper, subsequent processing of the record copy will require that it be subject to the addition of further information, in the form of markings or tags (*meta_data*), about the processing of the application (such as the date of receipt). That further information does not become part of the record copy in the strict sense, but rather is information associated with the record copy. In relation to that application for the purposes of Article 12 shall each consist of a copy in electronic form of that package.

³⁶ See Annex F, section 4.2.1. The wrapped and signed package (WASP) will be used for this purpose even if it is further packaged as a signed and encrypted package (SEP) (see Annex F, section 4.2.2) – that is, the SEP will be decrypted and the WASP extracted from the decrypted package. The other components of the SEP will be stored by the receiving Office as part of its records, but do not form part of the home copy or record copy. Similarly, any physical medium does not form part of the home copy or record copy (see Section 705(c)).

³⁷ The keeping of records in general by the receiving Office, including the time for which records must be kept, is governed by Rule 93.1. Where the application is encrypted or infected by a virus, the operation of this Section depends on whether the receiving Office decides to receive the application and on whether it can be decrypted or disinfected so as to enable an international filing date to be accorded.

³⁸ See Annex F, Appendix IV.

³⁹ This provision is intended to ensure that the originally filed physical medium containing the international application as filed is retained for evidentiary purposes as part of the receiving Office's records, even though it does not form part of the home copy or the record copy.

⁴⁰ The backup procedures provided for in Section 706 are optional for both receiving Offices and applicants. It has been included with a view particularly to addressing the concerns of those applicants and receiving Offices which are less familiar with and experienced in the filing and processing of applications in electronic form. It is noted that any applicant who wishes to make a parallel filing on paper of an application filed in electronic form is in any event at liberty to do so. The 16-month time limit corresponds to the time limit for performing certain other actions which must be completed before international publication.

ADMINISTRATIVE INSTRUCTIONS UNDER THE PCT

Office so permits and within 16 months from the priority date, file a backup copy of the application on paper or on a physical medium in accordance with Annex F, provided that the backup copy shall be identified as such and shall be accompanied by a statement by the applicant that the content of the backup copy is identical to that of the application as filed in electronic form.⁴¹

(b) Where an international application was filed in electronic form, the receiving Office may, of its own volition or at the request of the applicant, prepare a backup copy of the application on paper or on a physical medium in accordance with Annex F, provided that the content of the backup copy shall be identical to that of the application as filed in electronic form. The Office shall, upon request by the applicant and subject to the payment of a fee, send to the applicant a copy of such a backup copy.

(c) The receiving Office shall mark any backup copy filed or prepared on paper⁴² with the words “BACKUP COPY” or their equivalent in the language of publication of the international application on the bottom of the first page of the request and on the first page of the description.

(d) The applicant may, within 16 months from the priority date, request the receiving Office to substitute a backup copy filed in accordance with paragraph (a), or prepared in accordance with paragraph (b), for the application in electronic form, in which case the backup copy shall be considered to be replacement sheets effecting a correction under Rule 26. The replacement sheets shall be considered to have been received by the receiving Office on the date on which it received the applicant’s request.

Section 707

International Filing Fee; Fee Reduction

(a) Subject to paragraph (a-bis), where an international application is filed in electronic form, the international filing fee shall be calculated on the basis of the number of sheets that the application would

contain if presented as a print-out on paper complying with the physical requirements prescribed in Rule 11.

(a-bis) Where the international application is filed in electronic form and contains a sequence listing as referred to in Rule 5.2(a), the international filing fee shall comprise the following two components:

(i) a basic component calculated on the basis of the number of sheets that the international application would contain if presented as a print-out on paper complying with the physical requirements prescribed in Rule 11, excluding the sheets containing the sequence listing and/or any tables related to that sequence listing; and

(ii) an additional component, in respect of the sheets containing the sequence listing and/or any tables related to that sequence listing, calculated on the basis of the number of sheets of the sequence listing and/or any tables if presented as a print-out on paper complying with the physical requirements prescribed in Rule 11, provided that any sheet of the sequence listing and/or any tables in excess of 400 sheets shall not require the payment of a fee per sheet as referred to in item 1 of the Schedule of Fees.

(b) Item 3(b) and (c) of the Schedule of Fees annexed to the Regulations shall apply to reduce the fees payable in respect of an international application filed in electronic form with a receiving Office which has notified the International Bureau under Section 710(a) that it is prepared to receive international applications in electronic form.

Section 708

Special Provisions Concerning Legibility, Completeness, Infection by Viruses, Etc.

(a) Where an international application is transmitted⁴³ to the receiving Office in electronic form, the Office shall promptly check whether the application is legible and whether it appears to have been fully received.⁴⁴ Where the Office finds that all or part of the international application is illegible or that part of

⁴¹ See Annex F, Appendix IV, paragraph 2(d).

⁴² A backup copy filed on a physical medium similarly must be appropriately identified as such (see Section 706(a) and (b) and Annex F, Appendix IV, paragraph 2(d)).

⁴³ The word “transmitted” is to be understood in a general sense as including transmittal by either electronic or physical means, noting that an international application may be filed on physical media (see Annex F, Appendix IV).

the application appears not to have been received, the international application shall be treated as not having been received to the extent that it is illegible or, where transmitted by electronic means, that the attempted transmission failed, and the Office shall, if practicable⁴⁵ having regard to the indications furnished by the applicant, promptly notify the applicant accordingly.^{46, 47}

(b) Where a purported international application is transmitted to the receiving Office in electronic form, the Office shall promptly check it for infection by viruses and other forms of malicious logic⁴⁸. Where the Office finds that the purported application is so infected.

(i) the Office is not required to disinfect the purported application and may, under Section 703(e), refuse to receive it;

(ii) if the Office decides under Section 703(e) to receive the purported application, the Office shall use means reasonably available under the circumstances to read it, for example, by disinfecting it or preparing a backup copy under Section 706, and to store it in such a way that its contents may be ascertained if necessary;⁴⁹

(iii) if the Office finds that it is able to read and store the purported application as mentioned in item (ii), it shall determine whether an international filing date should be accorded;

(iv) if the Office accords an international filing date to the application, it shall, if possible having regard to the indications furnished by the applicant, promptly notify the applicant and, if necessary, invite

the applicant to submit a substitute copy of the application free of infection;

(v) if the Office accords an international filing date to the application, it shall prepare the home copy, the record copy and the search copy on the basis of the disinfected application, the backup copy or the substitute copy referred to in items (ii) or (iv), as applicable, provided that the application shall be stored by the Office, as referred to in item (ii), for the purposes of Rule 93.1.⁵⁰

Section 709

Means of Communication

(a) Where an international application is filed in electronic form and by electronic means of transmittal, the receiving Office shall, if practicable,⁵¹ send any notifications, invitations and other correspondence to the applicant by electronic means of transmittal in accordance with Annex F, or by such other means indicated by the applicant from among those offered by the Office.

(b) Where it appears to the receiving Office that a notification, invitation or other correspondence sent to the applicant by electronic means of transmittal was not successfully transmitted, the Office shall, if practicable,⁵² promptly retransmit the notification, invitation or other correspondence by the same or another means.⁵²

(c) At times when the electronic systems of the receiving Office are not available for the filing of documents in electronic form or by electronic means of transmittal, the Office shall, if possible, promptly

⁴⁴ The receiving Office is expected, of course, to take reasonable steps to attempt to read the application. The checking may be automated to the extent possible.

⁴⁵ See footnote 29.

⁴⁶ Where the International Bureau finds that the record copy of an international application filed in electronic form as received by it is illegible, it will notify the receiving Office which will then, where applicable, proceed under Section 708(a).

⁴⁷ Where the international application is treated as not having been received to the extent that it is illegible or that the attempted transmission failed, the receiving Office would then determine whether a filing date should be granted on the basis of that much of the application as was received.

⁴⁸ Where the International Bureau finds that the record copy of an international application filed in electronic form as received by it is infected by a virus, it will notify the receiving Office which will then, where applicable, proceed under Section 708(b).

⁴⁹ Since the originally filed application may need to be referred to for evidentiary purposes, the receiving Office should if possible store it as filed, that is, in its infected state.

⁵⁰ Since the originally filed application may need to be referred to for evidentiary purposes, the receiving Office should if possible store it as filed, that is, in its infected state.

⁵¹ See footnote 29.

ADMINISTRATIVE INSTRUCTIONS UNDER THE PCT

publish information to that effect by means reasonably available to it under the circumstances, for example, by including a notice on the Office's Internet site, if any.

Section 710

Notification and Publication of Receiving Offices' Requirements and Practices

(a) A notification by a receiving Office to the International Bureau under Rule 89.1(d) that it is prepared to receive international applications in electronic form shall indicate, where applicable:⁵³

(i) the electronic document formats, means of transmittal, electronic filing software and types of electronic signature specified by it under Section 703(b)(i), (ii) and (iv), and (c), and any options specified by it under the basic common standard;

(ii) the conditions, rules and procedures relating to electronic receipt, including hours of operation, choices for processes to verify or acknowledge receipt, choices for electronic communication of invitations and notifications, any methods of online payment, details concerning any help desks, electronic and software requirements and other administrative matters related to the electronic filing of international applications and related documents;

(iii) the kinds of documents which may be transmitted to or by the Office in electronic form;

(iv) whether and under what conditions the Office accepts the filing of backup copies under Section 706(a);

(v) procedures for notification of applicants and procedures which applicants may follow as alter-

natives when the electronic systems of the Office are not available;

(vi) where applicable, certification authorities accepted by the Office, and the electronic address of a listing of the certificate policies under which the certificates are issued;

(vii) the procedures relating to access to the files of international applications filed or stored in electronic form.

(b) The receiving Office shall notify the International Bureau of any change in the matters previously indicated by it in a notification under paragraph (a).

(c) The International Bureau shall promptly publish in the Gazette any notification received by it under paragraph (a) or (b).

(d) The effective date of any change notified under paragraph (b) shall be as specified by the receiving Office in the notification, provided that any change which restricts filing options shall not be effective earlier than two months after the date of publication of the notification of the change in the Gazette.

Section 711

Electronic Records Management

(a) Records, copies and files in relation to international applications in electronic form shall be maintained and stored, for the purposes of Rule 93, in accordance with the requirements of authentication, integrity, confidentiality and non-repudiation, and having due regard to the principles of electronic records management, set out in Annex F.⁵⁴

⁵² Section 709(b) as presently drafted does not impose any requirement for the receiving Office to ascertain whether an electronic communication sent by it has in fact been received by the applicant. Further consideration should be given to developing suitable systems. Those systems could then be included as Annex F requirements and suitable wording included in Section 709(b).

⁵³ A receiving Office is, of course, obliged to notify the International Bureau of the matters referred to in Section 710(a) only when it intends itself to commence receiving international applications in electronic form.

⁵⁴ See Annex F, section 2.2.2.1, as to the requirements of authentication, etc., and Annex F, section 8, as to the principles of electronic records management. At some future stage, Annex F could be modified to refer to the international standard for records management (ISO 15489), once that standard has been adopted, or to some other guidelines for electronic records management.

(b) Upon request by the applicant or other interested party in relation to a particular international application, the receiving Office shall, subject to any restrictions applicable under the Treaty as to access by third parties,⁵⁵ certify that any electronic records relating to that application are maintained and stored by it in accordance with paragraph (a).

Section 712

Access to Electronic Records

Access permitted by the Treaty, the Regulations or these Administrative Instructions to documents contained in the file of an international application filed or stored in electronic form may, at the option of the national Office or intergovernmental organization concerned, be provided by electronic means or in electronic form, having due regard to the need to ensure the integrity and where applicable confidentiality of data, the principles of electronic records management set out in Annex F,⁵⁶ and the need to ensure security of the electronic networks, systems and applications of the Office or organization.

Section 713

Provisions Relating to International Authorities and Designated Offices⁵⁷

(a) The provisions of this Part shall apply *mutatis mutandis* to the International Searching Authorities

and International Preliminary Examining Authorities and to the International Bureau.⁵⁸

(b) Any transmittal in electronic form of documents, notifications, communications or correspondence between receiving Offices, International Searching Authorities, International Preliminary Examining Authorities, the International Bureau and designated Offices⁵⁹ and Authorities concerned in accordance with Annex F.⁶⁰

(c) Where any International Searching Authority, International Preliminary Examining Authority or designated Office has not notified the International Bureau in accordance with Rule 89^{bis}.1(d) that it is prepared to process international applications in electronic form, the International Bureau shall furnish to that Office or Authority a copy on paper of any document which is stored by the International Bureau in electronic form and which that Office or Authority is entitled to receive. The International Bureau may also, upon request by the Authority or Office concerned, furnish such copy in electronic form.⁶¹

(d) Any designated Office may require that any document or correspondence submitted to it by the applicant in electronic form be signed by the applicant using a type of electronic signature specified by it in accordance with Annex F.⁶²

⁵⁵ Articles 30 and 38 and Rule 94 restrict access.

⁵⁶ See Annex F, section 8.

⁵⁷ Provisions of Part 7 and Annex F relating to the form or contents of the international application would automatically, by virtue of Article 27(1), be applicable to designated Offices. Communications between applicants and designated Offices would not, however, be governed in general by Annex F.

⁵⁸ In relation to Sections 703(a) and 710, an Office acting in more than one capacity (receiving Office, International Searching Authority and/or International Preliminary Examining Authority) would give separate notices to the International Bureau, in each capacity, as to its readiness to receive and process international applications in electronic form.

⁵⁹ "Designated Offices" necessarily includes elected Offices.

⁶⁰ See Rule 89.3 and Annex F, sections 5.2.2 and 5.2.3.

⁶¹ As to communications between applicants and designated Offices, see footnote 58.

⁶² See Section 704(g) in relation to the international phase, and Annex F, section 3.3.

PART 8

**INSTRUCTIONS RELATING TO INTERNATIONAL APPLICATIONS
CONTAINING LARGE NUCLEOTIDE AND/OR AMINO ACID SEQUENCE
LISTINGS AND/OR TABLES RELATING THERETO**

Section 801

**Filing of International Applications Containing
Sequence Listings and/or Tables**

(a) Pursuant to Rules 89^{bis} and 89^{ter}, where an international application contains disclosure of one or more nucleotide and/or amino acid sequence listings (“sequence listings”), the receiving Office may, if it is prepared to do so, accept that the sequence listing part of the description, as referred to in Rule 5.2(a) and/or any table related to the sequence listing(s) (“sequence listings and/or tables”), be filed, at the option of the applicant:

(i) only on an electronic medium in the computer readable form referred to in Section 802; or

(ii) both on an electronic medium in that computer readable form and on paper in the written form referred to in Section 802;

provided that the other elements of the international application are filed as otherwise provided for under the Regulations and these Instructions.

(b) Any receiving Office which is prepared to accept the filing in computer readable form of the sequence listings and/or tables under paragraph (a) shall notify the International Bureau accordingly. The notification shall specify the electronic media on which the receiving Office will accept such filings. The International Bureau shall promptly publish any such information in the Gazette.

(c) A receiving Office which has not made a notification under paragraph (b) may nevertheless decide in a particular case to accept an international application the sequence listings and/or tables of which are filed with it under paragraph (a).

(d) Where the sequence listings and/or tables are filed in computer readable form under paragraph (a) but not on an electronic medium specified by the receiving Office under paragraph (b), that Office shall, under Article 14(1)(a)(v), invite the applicant to furnish to it replacement sequence listings and/or tables on an electronic medium specified under paragraph (b).

(e) Where an international application containing sequence listings and/or tables in computer readable form is filed under paragraph (a) with a receiving Office which is not prepared, under paragraph (b) or (c), to accept such filings, Section 333(b) and (c) shall apply.

Section 802

**Format and Identification Requirements Relating
to International Applications Containing Sequence
Listings and/or Tables**

(a) Paragraphs 40 to 45 of Annex C shall apply *mutatis mutandis* to the sequence listing part of an international application filed in computer readable form.

(b) Tables filed in computer readable form under Section 801(a) shall comply with Annex C-*bis*.

(b-*bis*) Any International Searching Authority which requires that sequence listings be furnished in computer readable form shall select from the technical requirements contained in Annex C-*bis* those which it will apply and it shall notify the International Bureau accordingly. The International Bureau shall promptly publish any such information in the Gazette.

(b-*ter*) Where sequence listings and tables are both filed in computer readable form under Section 801(a), such listings and tables shall, respectively, be contained on separate electronic carriers which shall contain no other programs or files.

(b-*quater*) Rule 13^{ter}.1 shall apply *mutatis mutandis* to any tables not complying with Annex C-*bis* and paragraph (b-*ter*)

(c) The label provided for in paragraph 44 of Annex C shall, in respect of the sequence listings and/or tables, also include, as the case may be, the following indications:

(i) that the sequence listings and/or tables are filed under Section 801(a);

(ii) where the sequence listings and/or tables in computer readable form are contained on more than one electronic carrier, the numbering of each such

carrier (for example, “DISK 1/3,” “DISK 2/3,” “DISK 3/3”);

(iii) where more than one copy of the sequence listings and/or tables in computer readable form has been filed, the numbering of each copy (for example, “COPY 1,” “COPY 2,” “COPY 3”).

(d) Where any correction under Rule 26.3, any rectification of an obvious error under Rule 91, or any amendment under Article 34 is submitted in respect of the sequence listings and/or tables filed, under Section 801(a)(i) or (ii), in computer readable form, replacement sequence listings and/or tables in computer readable form containing the entirety of the sequence listings and/or tables with the relevant correction, rectification or amendment shall be furnished and the label referred to in paragraph (c) shall be marked accordingly (for example, “SUBMITTED FOR CORRECTION,” “SUBMITTED FOR RECTIFICATION,” “SUBMITTED FOR AMENDMENT”). Where the sequence listings and/or tables were filed both in computer readable form and in written form under Section 801(a)(ii), replacement sheets containing the correction, rectification or amendment in question shall also be submitted in written form.

Section 803

Calculation of International Filing Fee for International Applications Containing Sequence Listings and/or Tables

Where sequence listings and/or tables are filed in electronic form under Section 801(a), the international filing fee payable in respect of that application shall include the following two components:

(i) a basic component calculated as provided in the Schedule of Fees in respect of all pages filed on paper (that is, all pages of the request, description (excluding sequence listings and/or tables if also filed on paper), claims, abstract and drawings), and

(ii) an additional component, in respect of the sequence listings and/or tables, equal to 400 times the fee per sheet as referred to in item 1 of the Schedule of Fees, regardless of the actual length of the sequence listings and/or tables filed in computer readable form and regardless of the fact that sequence listings and/or tables may have been filed both in written form and in computer readable form.

Section 804

Preparation, Identification and Transmittal of Copies of International Applications Containing Sequence Listings and/or Tables

(a) Where the sequence listings and/or tables are filed only in computer readable form under Section 801(a)(i), the record copy for the purposes of Article 12 shall consist of those elements of the international application filed on paper together with the sequence listings and/or tables filed in computer readable form.

(b) Where sequence listings and/or tables are filed both in computer readable form and in written form under Section 801(a)(ii), the record copy for the purposes of Article 12 shall consist of all the elements of the international application filed on paper, including the sequence listings and/or tables in written form.

(c) Where sequence listings and/or tables are filed in computer readable form under Section 801(a)(i) or (ii) in less than the number of copies required for the purposes of this Section, the receiving Office shall either:

(i) promptly prepare any additional copies required, in which case it shall have the right to fix a fee for performing that task and to collect such fee from the applicant; or

(ii) invite the applicant to promptly furnish the additional number of copies required, accompanied by a statement that the sequence listings and/or tables in computer readable form contained in those copies are identical to the sequence listings and/or tables in computer readable form as filed;

provided that, where those sequence listings and/or tables were also filed in written form under Section 801(a)(ii), the receiving Office shall not, notwithstanding Rule 11.1(b), require the applicant to file additional copies of the sequence listings and/or tables in written form.

(d) Where the sequence listings and/or tables are filed under Section 801(a)(i), the receiving Office shall, in addition to proceeding under Section 305 with respect to the parts of the international application filed on paper:

(i) mark the words “RECORD COPY—SEQUENCE LISTINGS AND/OR TABLES” on the original electronic medium containing the sequence listings and/or tables part in computer readable form

ADMINISTRATIVE INSTRUCTIONS UNDER THE PCT

and transmit that part of the record copy to the International Bureau together with the paper part of the record copy;

(ii) mark the words “SEARCH COPY—SEQUENCE LISTINGS AND/OR TABLES” on one additional copy of the electronic medium containing the sequence listings and/or tables in computer readable form and transmit that part of the search copy to the International Searching Authority, for the purposes of Rule 13^{ter}.1, together with the paper part of the search copy;

(iii) mark the words “HOME COPY—SEQUENCE LISTINGS AND/OR TABLES” on the other such copy of the electronic medium containing the sequence listings and/or tables in computer readable form and keep that part of the home copy in its files together with the paper part of the home copy.

(e) Where the sequence listings and/or tables are filed under Section 801(a)(ii), the receiving Office shall, in addition to proceeding under Section 305 with respect to the parts of the international application filed on paper:

(i) mark the words “RECORD COPY—SEQUENCE LISTINGS AND/OR TABLES” in the upper left-hand corner of the first page of the sequence listing and of the first page of the first table in written form and transmit that part of the record copy to the International Bureau together with the paper part of the record copy; it shall also mark the words “COPY FOR INTERNATIONAL BUREAU—SEQUENCE LISTINGS AND/OR TABLES” on one copy of the electronic medium containing the sequence listings and/or tables in computer readable form and transmit that copy with the record copy;

(ii) mark the words “SEARCH COPY—SEQUENCE LISTINGS AND/OR TABLES” on one additional copy of the electronic medium containing the sequence listings and/or tables in computer readable form and transmit that part of the search copy to the International Searching Authority, for the purposes of Rule 13^{ter}.1, together with the paper part of the search copy;

(iii) mark the words “HOME COPY—SEQUENCE LISTINGS AND/OR TABLES” on the other such copy of the electronic medium containing the sequence listings and/or tables in computer readable form and keep that part of the home copy in its files together with the paper part of the home copy.

(f) The receiving Office may, when marking the copies referred to in paragraphs (d) and (e), use, instead of the words referred to in those paragraphs, the equivalent of those words in the language of publication of the international application.

Section 805

Publication and Communication of International Applications Containing Sequence Listings and/or Tables; Copies; Priority Documents

(a) Notwithstanding Section 406, an international application containing sequence listings and/or tables may be published under Article 21, in whole or in part, in electronic form as determined by the Director General.

(b) Paragraph (a) shall apply *mutatis mutandis* in relation to:

(i) the communication of an international application under Article 20;

(ii) the furnishing of copies of an international application under Rules 87 and 94.1;

(iii) the furnishing under Rule 17.1, as a priority document, of a copy of an international application containing sequence listings and/or tables filed under Section 801(a);

(iv) the furnishing under Rules 17.2 and 66.7 of copies of a priority document.

Section 806

Sequence Listings and/or Tables for Designated Office

(a) Where sequence listings and/or tables were filed only in computer readable form under Section 801(a)(i), any designated Office which does not accept the filing of sequence listings and/or tables in computer readable form may require that the applicant furnish to it, for the purposes of the national phase, a copy on paper of such sequence listings in written form complying with Annex C and a copy on paper of such tables in written form, accompanied by a statement that the sequence listings and/or tables in written form are identical to the sequence listings and/or tables in computer readable form.

(b) Rule 13^{ter}.2 shall apply *mutatis mutandis* to any tables filed under Section 801(a).

(c) For the purposes of Rule 49.5, any designated Office may require that the applicant furnish to

MANUAL OF PATENT EXAMINING PROCEDURE

it a translation of any text matter contained in any tables filed under Section 801(a), if that text matter is not in the language-neutral vocabulary referred to in

Annex C and if it does not appear in the main part of the description in the language thereof.
[Annexes follow]

ADMINISTRATIVE INSTRUCTIONS UNDER THE PCT

ANNEX A

FORMS

[This Annex, which is not reproduced here, contains Forms for use by applicants and by the International Authorities, including those referred to in Section 102 of the Administrative Instructions. It consists of five Parts, which are available separately from WIPO, as follows:

Part I: Forms Relating to the Receiving Office;

Part II: Forms Relating to the International Searching Authority;

Part III: Forms Relating to the International Bureau;

Part IV: Forms Relating to the International Preliminary Examining Authority;

Part V: Request and Demand Forms.]

[Annex B follows]

ANNEX B

UNITY OF INVENTION

PART 1

INSTRUCTIONS CONCERNING UNITY OF INVENTION

(a) **Unity of Invention.** Rule 13.1 deals with the requirement of unity of invention and states the principle that an international application should relate to only one invention or, if there is more than one invention, that the inclusion of those inventions in one international application is only permitted if all inventions are so linked as to form a single general inventive concept.

(b) **Technical Relationship.** Rule 13.2 defines the method for determining whether the requirement of unity of invention is satisfied in respect of a group of inventions claimed in an international application. Unity of invention exists only when there is a technical relationship among the claimed inventions involving one or more of the same or corresponding special technical features. The expression “special technical features” is defined in Rule 13.2 as meaning those technical features that define a contribution which each of the inventions, considered as a whole, makes over the prior art. The determination is made on the contents of the claims as interpreted in light of the description and drawings (if any).

(c) **Independent and Dependent Claims.** Unity of invention has to be considered in the first place only in relation to the independent claims in an international application and not the dependent claims. By “dependent” claim is meant a claim which contains all the features of another claim and is in the same category of claim as that other claim (the expression “category of claim” referring to the classification of claims according to the subject matter of the invention claimed for example, product, process, use or apparatus or means, etc.).

(i) If the independent claims avoid the prior art and satisfy the requirement of unity of invention, no problem of lack of unity arises in respect of any claims that depend on the independent claims. In particular, it does not matter if a dependent claim itself contains a further invention. Equally, no problem arises in the case of a genus/species situation where

the genus claim avoids the prior art. Moreover, no problem arises in the case of a combination/subcombination situation where the subcombination claim avoids the prior art and the combination claim includes all the features of the subcombination.

(ii) If, however, an independent claim does not avoid the prior art, then the question whether there is still an inventive link between all the claims dependent on that claim needs to be carefully considered. If there is no link remaining, an objection of lack of unity *a posteriori* (that is, arising only after assessment of the prior art) may be raised. Similar considerations apply in the case of a genus/species or combination/subcombination situation.

(iii) This method for determining whether unity of invention exists is intended to be applied even before the commencement of the international search. Where a search of the prior art is made, an initial determination of unity of invention, based on the assumption that the claims avoid the prior art, may be reconsidered on the basis of the results of the search of the prior art.

(d) **Illustrations of Particular Situations.** There are three particular situations for which the method for determining unity of invention contained in Rule 13.2 is explained in greater detail:

- (i) combinations of different categories of claims;
- (ii) so-called “Markush practice”; and
- (iii) intermediate and final products.

Principles for the interpretation of the method contained in Rule 13.2, in the context of each of those situations are set out below. It is understood that the principles set out below are, in all instances, interpretations of and not exceptions to the requirements of Rule 13.2.

Examples to assist in understanding the interpretation on the three areas of special concern referred to in the preceding paragraph are set out below.

(e) **Combinations of Different Categories of Claims.** The method for determining unity of invention under Rule 13 shall be construed as permitting, in particular, the inclusion of any one of the following combinations of claims of different categories in the same international application:

(i) in addition to an independent claim for a given product, an independent claim for a process specially adapted for the manufacture of the said product, and an independent claim for a use of the said product, or

(ii) in addition to an independent claim for a given process, an independent claim for an apparatus or means specifically designed for carrying out the said process, or

(iii) in addition to an independent claim for a given product, an independent claim for a process specially adapted for the manufacture of the said product and an independent claim for an apparatus or means specifically designed for carrying out the said process, it being understood that a process is specially adapted for the manufacture of a product if it inherently results in the product and that an apparatus or means is specifically designed for carrying out a process if the contribution over the prior art of the apparatus or means corresponds to the contribution the process makes over the prior art.

Thus, a process shall be considered to be specially adapted for the manufacture of a product if the claimed process inherently results in the claimed product with the technical relationship being present between the claimed product and claimed process. The words “specially adapted” are not intended to imply that the product could not also be manufactured by a different process.

Also an apparatus or means shall be considered to be “specifically designed for carrying out” a claimed process if the contribution over the prior art of the apparatus or means corresponds to the contribution the process makes over the prior art. Consequently, it would not be sufficient that the apparatus or means is merely capable of being used in carrying out the claimed process. However, the expression “specifically designed” does not imply that the apparatus or means could not be used for carrying out another process, nor that the process could not be carried out using an alternative apparatus or means.

(f) **“Markush Practice.”** The situation involving the so-called “Markush practice” wherein a single claim defines alternatives (chemical or non-chemical) is also governed by Rule 13.2. In this special situation, the requirement of a technical interrelationship and the same or corresponding special technical features as defined in Rule 13.2, shall be considered to be met when the alternatives are of a similar nature.

(i) When the Markush grouping is for alternatives of chemical compounds, they shall be regarded as being of a similar nature where the following criteria are fulfilled:

(A) all alternatives have a common property or activity, and

(B)(1) a common structure is present, i.e., a significant structural element is shared by all of the alternatives, or

(B)(2) in cases where the common structure cannot be the unifying criteria, all alternatives belong to a recognized class of chemical compounds in the art to which the invention pertains.

(ii) In paragraph (f)(i)(B)(1), above, the words “significant structural element is shared by all of the alternatives” refer to cases where the compounds share a common chemical structure which occupies a large portion of their structures, or in case the compounds have in common only a small portion of their structures, the commonly shared structure constitutes a structurally distinctive portion in view of existing prior art. The structural element may be a single component or a combination of individual components linked together.

(iii) In paragraph (f)(i)(B)(2), above, the words “recognized class of chemical compounds” mean that there is an expectation from the knowledge in the art that members of the class will behave in the same way in the context of the claimed invention. In other words, each member could be substituted one for the other, with the expectation that the same intended result would be achieved.

(iv) The fact that the alternatives of a Markush grouping can be differently classified shall not, taken alone, be considered to be justification for a finding of a lack of unity of invention.

(v) When dealing with alternatives, if it can be shown that at least one Markush alternative is not novel over the prior art, the question of unity of invention shall be reconsidered by the examiner.

Reconsideration does not necessarily imply that an objection of lack of unity shall be raised.

(g) **Intermediate and Final Products.** The situation involving intermediate and final products is also governed by Rule 13.2.

(i) The term “intermediate” is intended to mean intermediate or starting products. Such products have the ability to be used to produce final products through a physical or chemical change in which the intermediate loses its identity.

(ii) Unity of invention shall be considered to be present in the context of intermediate and final products where the following two conditions are fulfilled:

(A) the intermediate and final products have the same essential structural element, in that:

(1) the basic chemical structures of the intermediate and the final products are the same, or

(2) the chemical structures of the two products are technically closely interrelated, the intermediate incorporating an essential structural element into the final product, and

(B) the intermediate and final products are technically interrelated, this meaning that the final product is manufactured directly from the intermediate or is separated from it by a small number of intermediates all containing the same essential structural element.

(iii) Unity of invention may also be considered to be present between intermediate and final products of which the structures are not known—for example, as between an intermediate having a known structure and a final product the structure of which is not known, or as between an intermediate of unknown structure and a final product of unknown structure. In order to satisfy unity in such cases, there shall be sufficient evidence to lead one to conclude that the intermediate and final products are technically closely interrelated as, for example, when the intermediate contains the same essential element as the final product or incorporates an essential element into the final product.

(iv) It is possible to accept in a single international application different intermediate products used in different processes for the preparation of the final product, provided that they have the same essential structural element.

(v) The intermediate and final products shall not be separated, in the process leading from one to the other, by an intermediate which is not new.

(vi) If the same international application claims different intermediates for different structural parts of the final product, unity shall not be regarded as being present between the intermediates.

(vii) If the intermediate and final products are families of compounds, each intermediate compound shall correspond to a compound claimed in the family of the final products. However, some of the final products may have no corresponding compound in the family of the intermediate products so that the two families need not be absolutely congruent.

(h) As long as unity of invention can be recognized applying the above interpretations, the fact that, besides the ability to be used to produce final products, the intermediates also exhibit other possible effects or activities shall not affect the decision on unity of invention.

(i) Rule 13.3 requires that the determination of the existence of unity of invention be made without regard to whether the inventions are claimed in separate claims or as alternatives within a single claim.

(j) Rule 13.3 is not intended to constitute an encouragement to the use of alternatives within a single claim, but is intended to clarify that the criterion for the determination of unity of invention (namely, the method contained in Rule 13.2) remains the same regardless of the form of claim used.

(k) Rule 13.3 does not prevent an International Searching or Preliminary Examining Authority or an Office from objecting to alternatives being contained within a single claim on the basis of considerations such as clarity, the conciseness of claims or the claims fee system applicable in that Authority or Office.

[ANNEX B, CONTINUED]
PART 2

EXAMPLES CONCERNING UNITY OF INVENTION

The application of the principles of unity of invention is illustrated by the following examples for guidance in particular cases.

I. CLAIMS IN DIFFERENT CATEGORIES

Example 1

Claim 1: A method of manufacturing chemical substance X.

Claim 2: Substance X.

Claim 3: The use of substance X as an insecticide.

Unity exists between claims 1, 2 and 3. The special technical feature common to all the claims is substance X.

Example 2

Claim 1: A process of manufacture comprising steps A and B.

Claim 2: Apparatus specifically designed for carrying out step A.

Claim 3: Apparatus specifically designed for carrying out step B.

Unity exists between claims 1 and 2 or between claims 1 and 3. There is no unity between claims 2 and 3 since there exists no common special technical feature between the two claims.

Example 3

Claim 1: A process for painting an article in which the paint contains a new rust inhibiting substance X including the steps of atomizing the paint using compressed air, electrostatically charging the atomized paint using a novel electrode arrangement A and directing the paint to the article.

Claim 2: A paint containing substance X.

Claim 3: An apparatus including electrode arrangement A.

Unity exists between claims 1 and 2 where the common special technical feature is the paint containing substance X or between claims 1 and 3 where the common special technical feature is the electrode arrangement A.

However, unity is lacking between claims 2 and 3 since there exists no common special technical feature between them.

Example 4

Claim 1: Use of a family of compounds X as insecticides.

Claim 2: Compound X₁ belonging to family X.

Provided X₁ has the insecticidal activity and the special technical feature in claim 1 is the insecticidal use, unity is present.

Example 5

- Claim 1: A process for treating textiles comprising spraying the material with a particular coating composition under special conditions (e.g., as to temperature, irradiation).
- Claim 2: A textile material coated according to the process of claim 1.
- Claim 3: A spraying machine for use in the process of claim 1 and characterized by a new nozzle arrangement providing a better distribution of the composition being sprayed.

The process according to claim 1 imparts unexpected properties to the product of claim 2.

The special technical feature in claim 1 is the use of special process conditions corresponding to what is made necessary by the choice of the particular coating. Unity exists between claims 1 and 2.

The spraying machine in claim 3 does not correspond to the above identified special technical feature. Unity does not exist between claim 3 and claims 1 and 2.

Example 6

- Claim 1: A fuel burner with tangential fuel inlets into a mixing chamber.
- Claim 2: A process for making a fuel burner including the step of forming tangential fuel inlets into a mixing chamber.
- Claim 3: A process for making a fuel burner including casting step A.
- Claim 4: An apparatus for carrying out a process for making a fuel burner including feature X resulting in the formation of tangential fuel inlets.
- Claim 5: An apparatus for carrying out a process for making a fuel burner including a protective housing B.
- Claim 6: A process of manufacturing carbon black including the step of tangentially introducing fuel into a mixing chamber of a fuel burner.

Unity exists between claims 1, 2, 4, and 6. The special technical feature common to all the claims is the tangential fuel inlets. Claims 3 and 5 lack unity with claims 1, 2, 4, and 6 since claims 3 and 5 do not include the same or corresponding special technical feature as set forth in claims 1, 2, 4, and 6. Claims 3 and 5 would also lack unity with one another.

Example 7

- Claim 1: A high corrosion resistant and high strength ferritic stainless steel strip consisting essentially of, in percent by weight: Ni=2.0-5.0; Cr=15-19; Mo=1-2; and the balance Fe having a thickness of between 0.5 and 2.0 mm and a 0.2% yield strength in excess of 50 kg/mm squared.
- Claim 2: A method of producing a high corrosion resistant and high strength ferritic stainless steel strip consisting essentially of, in percent by weight: Ni=2.0-5.0; Cr=15-19; Mo=1-2; and the balance Fe, comprising the steps of: hot rolling to a thickness between 2.0 and 5.0 mm; annealing the hot rolled strip at 800-1000 degrees C under substantially no oxidizing conditions; cold rolling the strip to a thickness of between 0.5 and 2.0 mm; and final annealing the cold rolled strip at between 1120 and 1200 degrees C for a period of 2-5 minutes.

ADMINISTRATIVE INSTRUCTIONS UNDER THE PCT

Unity exists between product claim 1 and process claim 2. The special technical feature in the product claim is the 0.2% yield strength in excess of 50 kg/mm squared. The process steps in claim 2 inherently produce a ferritic stainless steel strip with a 0.2% yield strength in excess of 50 kg/mm squared. Even if this feature is not apparent from the wording of claim 2, it is clearly disclosed in the description. Therefore said process steps are the special technical feature which correspond to the limitation in the product claim directed to the same ferritic stainless steel with the claimed strength characteristics.

II. CLAIMS IN THE SAME CATEGORY

Example 8

Claim 1: Plug characterized by feature A.

Claim 2: Socket characterized by corresponding feature A.

Feature A is a special technical feature which is included in both claims 1 and 2 and therefore unity is present.

Example 9

Claim 1: Transmitter provided with time axis expander for video signals.

Claim 2: Receiver provided with time axis compressor for video signals received.

Claim 3: Transmission equipment for video signals comprising a transmitter provided with time axis expander for video signals and a receiver provided with time axis compressor for video signals received.

The special technical features are in claim 1 the time axis expander, and in claim 2 the time axis compressor, which are corresponding technical features. Unity exists between claims 1 and 2. Claim 3 includes both special technical features and has unity with claims 1 and 2. The requirement for unity would still be met in the absence of the combination claim (claim 3).

Example 10

Claim 1: Conveyor belt with feature A.

Claim 2: Conveyor belt with feature B.

Claim 3: Conveyor belt with features A + B.

Feature A is a special technical feature and feature B is another unrelated special technical feature. Unity exists between claims 1 and 3 or between claims 2 and 3, but not between claims 1 and 2.

Example 11

Claim 1: Control circuit A for a d.c. motor.

Claim 2: Control circuit B for a d.c. motor.

Claim 3: An apparatus including a d.c. motor with control circuit A.

Claim 4: An apparatus including a d.c. motor with control circuit B.

Control circuit A is a special technical feature and control circuit B is another unrelated special technical feature. Unity exists between claims 1 and 3 or between claims 2 and 4, but not between claims 1 and 2 or 3 and 4.

Example 12

Claim 1: A display with features A + B.

Claim 2: A display according to claim 1 with additional feature C.

Claim 3: A display with features A + B with additional feature D.

Unity exists between claims 1, 2, and 3. The special technical feature common to all the claims is features A + B.

Example 13

Claim 1: Filament A for a lamp.

Claim 2: Lamp B having filament A.

Claim 3: Searchlight provided with lamp B having filament A and a swivel arrangement C.

Unity exists between claims 1, 2, and 3. The special technical feature common to all the claims is the filament A.

Example 14

Claim 1: A marking device for marking animals, comprising a disc-shaped element with a stem extending normally therefrom, the tip of which is designed to be driven through the skin of the animal to be marked, and a securing disk element to be fastened to the protruding tip of the stem on the other side of skin.

Claim 2: An apparatus for applying the marking device of claim 1, constructed as a pneumatically actuated gun for driving the stem of the disc-shaped element through the skin, and provided with a supporting surface adapted for taking up a securing disc element, to be placed at the other side of the body portion in question of the animal to be marked.

The special technical feature in claim 1 is the marking device having a disc-shaped element with a stem and a securing disc element to be fastened to the tip of the stem. The corresponding special technical feature in claim 2 is the pneumatically actuated gun for driving the marking device and having a supporting surface for the securing disc element. Unity exists between claims 1 and 2.

Example 15

Claim 1: Compound A.

Claim 2: An insecticide composition comprising compound A and a carrier.

Unity exists between claims 1 and 2. The special technical feature common to all the claims is compound A.

Example 16

Claim 1: An insecticide composition comprising compound A (consisting of a_1, a_2, \dots) and a carrier.

Claim 2: Compound a_1 .

ADMINISTRATIVE INSTRUCTIONS UNDER THE PCT

All compounds A are not claimed in the product claim 2 for reasons of lack of novelty of some of them for instance. There is nevertheless still unity between the subject matter of claims 1 and 2 provided a 1 has the insecticidal activity which is also the special technical feature for compound A in claim 1.

Example 17

Claim 1: Protein X

Claim 2: DNA sequence encoding protein X.

Expression of the DNA sequence in a host results in the production of a protein which is determined by the DNA sequence. The protein and the DNA sequence exhibit corresponding special technical features. Unity between claims 1 and 2 is accepted.

III. MARKUSH PRACTICE

Example 18— common structure:

Claim 1: A compound of the formula:

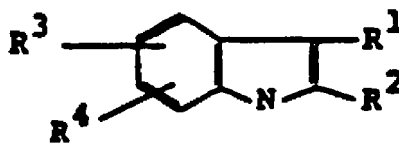

wherein R¹ is selected from the group consisting of phenyl, pyridyl, thiazolyl, triazinyl, alkylthio, alkoxy, and methyl; R²-R⁴ are methyl, benzyl, or phenyl. The compounds are useful as pharmaceuticals for the purpose of enhancing the capacity of the blood to absorb oxygen.

In this case the indolyl moiety is the significant structural element which is shared by all of the alternatives. Since all the claimed compounds are alleged to possess the same utility, unity is present.

Example 19— common structure:

Claim 1: A compound of the formula:

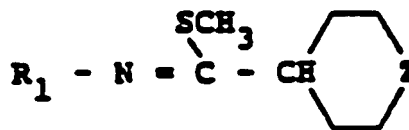

wherein R₁ is selected from the group consisting of phenyl, pyridyl, thiazolyl, triazinyl, alkylthio, alkoxy, and methyl; Z is selected from the group consisting of oxygen (O), sulfur (S), imino (NH), and methylene (-CH₂-). The compounds are alleged to be useful as pharmaceuticals for relieving lower back pain.

MANUAL OF PATENT EXAMINING PROCEDURE

In this particular case the iminothioether group $-N=C-SCH_3$ linked to a six atom ring is the significant structural element which is shared by all the alternatives. Thus, since all the claimed compounds are alleged to possess the same use, unity would be present. A six membered heterocyclic ring would not have been of sufficient similarity to allow a Markush grouping exhibiting unity, absent some teaching of equivalence in the prior art.

Example 20— common structure

Claim 1: A compound of the formula:

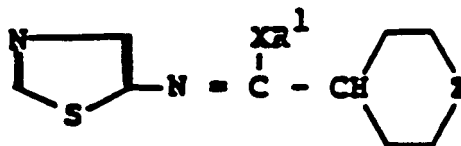

wherein R¹ is methyl or phenyl, X and Z are selected from oxygen (O) and sulfur (S).

The compounds are useful as pharmaceuticals and contain the 1,3-thiazolyl substituent which provides greater penetrability of mammalian tissue which fact makes the compounds useful as relievers for headaches and as topical anti-inflammatory agents.

All compounds share a common chemical structure, the thiazole ring and the six atom heterocyclic compound bound to an imino group, which occupy a large portion of their structure. A six membered heterocyclic ring would not have been of sufficient similarity to allow a Markush grouping exhibiting unity, absent some teaching of equivalence in the prior art.

Example 21— common structure:

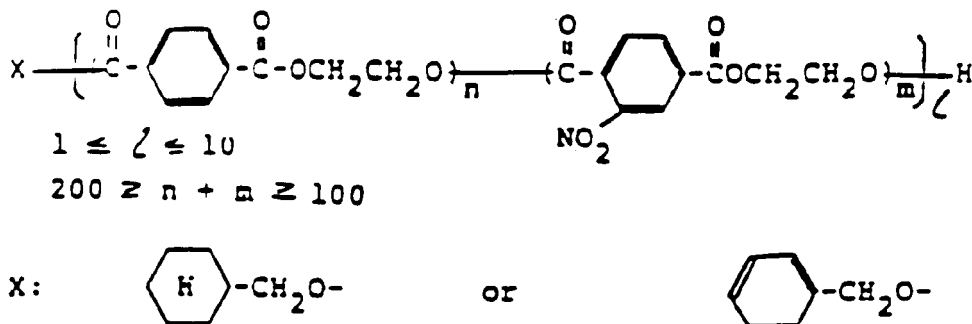

All of the above copolymers have in common a thermal degradation resistance property, due to the reduced number of free COOH radicals by esterification with X of the end COOH radicals which cause thermal degradation. The chemical structures of the alternatives are considered to be technically closely interrelated to one another. A grouping in one claim is therefore allowed.

ADMINISTRATIVE INSTRUCTIONS UNDER THE PCT

Example 22— common structure:

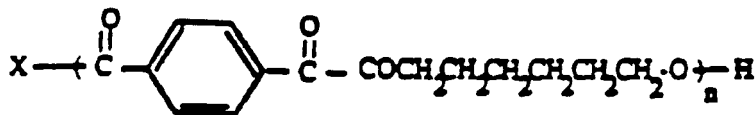

(polyhexamethyleneterephthalate)

$100 \geq n \geq 50$

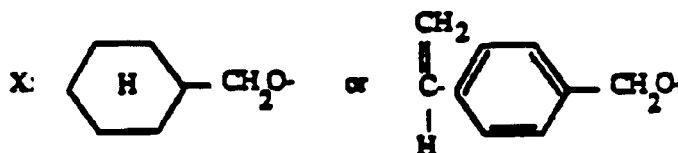

The compound obtained by esterifying the end COOH radical of known polyhexamethyleneterephthalate with $\text{C}_6\text{H}_{11}\text{CH}_2\text{O}-$ has a thermal degradation resistant property, due to the reduced number of free COOH radicals which cause thermal degradation. In contrast, the compound obtained by esterifying the end COOH radical of known polyhexamethyleneterephthalate with a vinyl compound containing a $\text{CH}_2 = \text{CH}-\text{C}_6\text{H}_4-\text{CH}_2\text{O}-$ moiety serves as a raw material for a setting resin when mixed with unsaturated monomer and cured (addition reaction).

All esters covered by the claim do not have a property or activity in common. For example, the product obtained through esterification with the “ $\text{CH}_2 = \text{CH}$ ” vinyl compound does not have a thermal degradation resistant property. The grouping in a single application is not allowed.

Example 23— No common structure:

Claim 1: A herbicidal composition consisting essentially of an effective amount of the mixture of A 2,4-D(2,4-dichlorophenoxy acetic acid) and B a second herbicide selected from the group consisting of copper sulfate, sodium chlorate, ammonium sulfamate, sodium trichloroacetate, dichloropropionic acid, 3-amino-2,5-dichlorobenzoic acid, diphenamid (an amide), ioxynil (nitrile), dinoseb (phenol), trifluralin (dinitroaniline), EPTC (thiocarbamate), and simazine (triazine) along with an inert carrier or diluent.

The different components under B must be members of a recognized class of compounds. Consequently in the present case a unity objection would be raised because the members of B are not recognized as a class of compounds, but, in fact, represent a plurality of classes which may be identified as follows:

- a) **inorganic salts:**
- copper sulfate
 - sodium chlorate
 - ammonium sulfamate

b) **organic salts and carboxylic acids:**

sodium trichloroacetate

dichloropropionic acid

3-amino-2,5-dichlorobenzoic acid

c) **amides:**

diphenamid

d) **nitriles:**

ioxynil

e) **phenols:**

dinoseb

f) **amines:**

trifluralin

g) **heterocyclic:**

simazine

Example 24

Claim 1: Catalyst for vapor phase oxidation of hydrocarbons, which consists of (X) or (X + a).

In this example (X) oxidizes RCH_3 into RCH_2OH and (X+a) oxidizes RCH_3 further into $RCOOH$.

Both catalysts share a common component and a common activity as oxidation catalyst for RCH_3 . With (X+a) the oxidation is more complete and goes until the carboxylic acid is formed but the activity still remains the same.

A Markush grouping is acceptable.

IV. INTERMEDIATE/FINAL PRODUCTS

Example 25

Claim 1:

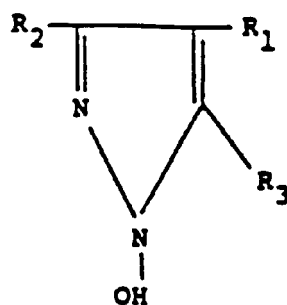

(intermediate)

ADMINISTRATIVE INSTRUCTIONS UNDER THE PCT

Claim 2:

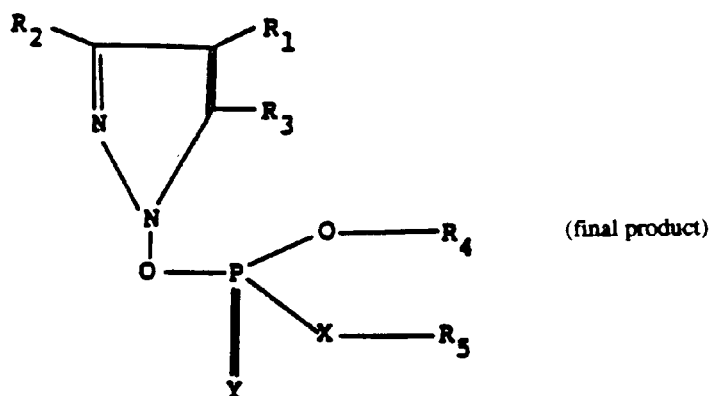

The chemical structures of the intermediate and final product are technically closely interrelated. The essential structural element incorporated into the final product is:

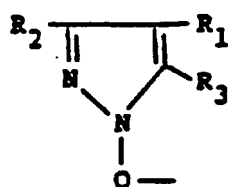

Therefore, unity exists between claims 1 and 2.

Example 26

Claim 1:

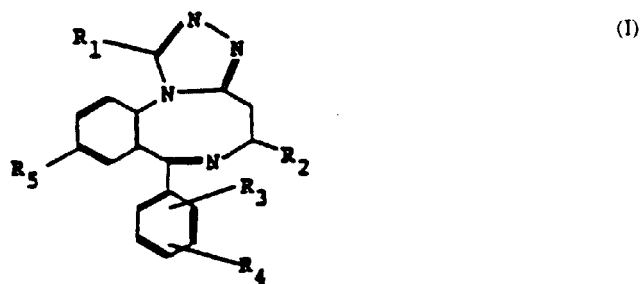

Claim 2:

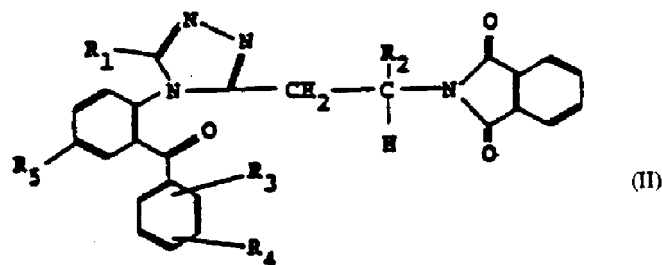

(II) is described as an intermediate to make (I). The closure mechanism is one well known in the art. Though the basic structures of compound (I) (final product) and compound (II) (intermediate) differ considerably, compound (II) is an open ring precursor to compound (I). Both compounds share a common essential structural element which is the linkage comprising the two phenyl rings and the triazole ring. The chemical structures of the two compounds are therefore considered to be technically closely interrelated.

The example therefore satisfies the requirement for unity of invention.

Example 27

Claim 1: Amorphous polymer A (intermediate).

Claim 2: Crystalline polymer A (final product).

In this example a film of the amorphous polymer A is stretched to make it crystalline. Here unity exists because there is an intermediate final product relation in that amorphous polymer A is used as a starting product to prepare crystalline polymer A.

For purposes of further illustration, assume that the polymer A in this example is polyisoprene. Here the intermediate, amorphous polyisoprene, and the final product, crystalline polyisoprene, have the same chemical structure.

Example 28

Claim 1: Polymeric compound useful as fiber material identified by the following general formula:

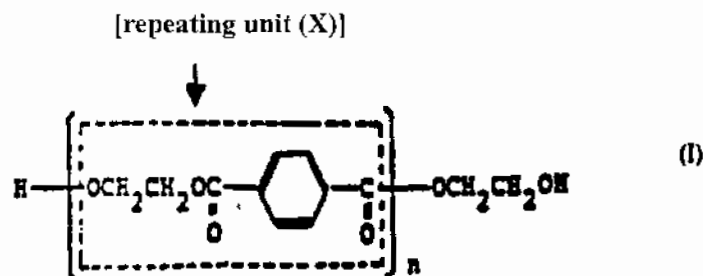

Claim 2: Compound identified by the following general formula: (useful as intermediate for polymeric compound I)

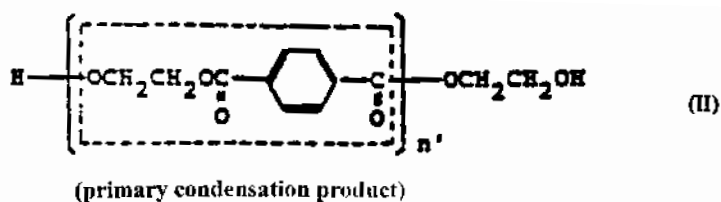

The two inventions are in an intermediate and final product relationship.

Substance (II) is a raw material for substance (I).

Meanwhile, both compounds share an essential structural element (repeating unit (X)) and are technically closely interrelated. The intermediate and final products therefore satisfy the requirements for unity.

Example 29

Claim 1: Novel compound having structure A (Intermediate).

Claim 2: Product prepared by reacting A with a substance X (Final Product).

Example 30

Claim 1: Reaction product of A and B (Intermediate).

Claim 2: Product prepared by reacting the reaction product of A and B with substances X and Y (Final Product).

In examples 29 and 30 the chemical structure(s) of the intermediate and/or the final product is not known. In (29) the structure of the product of claim 2 (the final product) is not known. In (30) the structures of the products of claim 1 (the intermediate) and claim 2 (the final product) are unknown. Unity exists if there is evidence which would lead one to conclude that the characteristic of the final product which is the inventive feature in the case is due to the intermediate. For example, the purpose for using the intermediates in (29) or (30) is to modify certain properties of the final product. The evidence may be in the form of test data in the specification showing the effect of the intermediate on the final product. If no such evidence exists then there is no unity on the basis of an intermediate-final product relationship.

[Annex C follows]

ANNEX C

STANDARD FOR THE PRESENTATION OF NUCLEOTIDE AND AMINO ACID SEQUENCE LISTINGS IN INTERNATIONAL PATENT APPLICATIONS UNDER THE PCT

Introduction

1. This Standard has been elaborated so as to provide standardization of the presentation of nucleotide and amino acid sequence listings in international patent applications. The Standard is intended to allow the applicant to draw up a single sequence listing which is acceptable to all receiving Offices, International Searching and Preliminary Examining Authorities for the purposes of the international phase, and to all designated and elected Offices for the purposes of the national phase. It is intended to enhance the accuracy and quality of presentations of nucleotide and amino acid sequences given in international applications, to make for easier presentation and dissemination of sequences for the benefit of applicants, the public and examiners, to facilitate searching of sequence data and to allow the exchange of sequence data in electronic form and the introduction of sequence data onto computerized databases.

Definitions

2. For the purposes of this Standard:

(i) the expression “sequence listing” means a part of the description of the application as filed or a document filed subsequently to the application, which gives a detailed disclosure of the nucleotide and/or amino acid sequences and other available information;

(ii) sequences which are included are any unbranched sequences of four or more amino acids or unbranched sequences of ten or more nucleotides. Branched sequences, sequences with fewer than four specifically defined nucleotides or amino acids as well as sequences comprising nucleotides or amino acids other than those listed in Appendix 2, Tables 1, 2, 3 and 4, are specifically excluded from this definition;

(iii) “nucleotides” embrace only those nucleotides that can be represented using the symbols set forth in Appendix 2, Table 1. Modifications, for example, methylated bases, may be described as set forth in Appendix 2, Table 2, but shall not be shown explicitly in the nucleotide sequence;

(iv) “amino acids” are those L-amino acids commonly found in naturally occurring proteins and are listed in Appendix 2, Table 3. Those amino acid sequences containing at least one D-amino acid are not intended to be embraced by this definition. Any amino acid sequence that contains post-translationally modified amino acids may be described as the amino acid sequence that is initially translated using the symbols shown in Appendix 2, Table 3, with the modified positions, for example, hydroxylations or glycosylations, being described as set forth in Appendix 2, Table 4, but these modifications shall not be shown explicitly in the amino acid sequence. Any peptide or protein that can be expressed as a sequence using the symbols in Appendix 2, Table 3, in conjunction with a description elsewhere to describe, for example, abnormal linkages, cross-links (for example, disulfide bridge) and end caps, non-peptidyl bonds, etc., is embraced by this definition;

(v) “sequence identifier” is a unique integer that corresponds to the SEQ ID NO assigned to each sequence in the listing;

(vi) “numeric identifier” is a three-digit number which represents a specific data element;

(vii) “language-neutral vocabulary” is a controlled vocabulary used in the sequence listing that represents scientific terms as prescribed by sequence database providers (including scientific names, qualifiers and their controlled-vocabulary values, the symbols appearing in Appendix 2, Tables 1, 2, 3 and 4, and the feature keys appearing in Appendix 2, Tables 5 and 6;

ADMINISTRATIVE INSTRUCTIONS UNDER THE PCT

(viii) “competent Authority” is the International Searching Authority that is to carry out the international search and to establish the written opinion of the International Searching Authority on the international application, or the International Preliminary Examining Authority that is to carry out the international preliminary examination on the international application, or the designated/elected Office before which the processing of the international application has started.

Sequence Listing

3. The sequence listing as defined in paragraph 2(i) shall, where it is filed together with the application, be placed at the end of the application. This part shall be entitled “Sequence Listing”, begin on a new page and preferably have independent page numbering. The sequence listing forms an integral part of the description; it is therefore unnecessary, subject to paragraph 36, to describe the sequences elsewhere in the description.

4. Where the sequence listing as defined in paragraph 2(i) is not contained in the application as filed but is a separate document furnished subsequently to the filing of the application (see paragraph 37), it shall be entitled “Sequence Listing” and shall have independent page numbering. The original numbering of the sequences (see paragraph 5) in the application as filed shall be maintained in the subsequently furnished sequence listing.

5. Each sequence shall be assigned a separate sequence identifier. The sequence identifiers shall begin with 1 and increase sequentially by integers. If no sequence is present for a sequence identifier, the code 000 should appear under numeric identifier <400>, beginning on the next line following the SEQ ID NO. The response for numeric identifier <160> shall include the total number of SEQ ID NOs, whether followed by a sequence or by the code 000.

6. In the description, claims or drawings of the application, the sequences represented in the sequence listing shall be referred to by the sequence identifier and preceded by “SEQ ID NO:”.

7. Nucleotide and amino acid sequences should be represented by at least one of the following three possibilities:

- (i) a pure nucleotide sequence;
- (ii) a pure amino acid sequence;
- (iii) a nucleotide sequence together with its corresponding amino acid sequence.

For those sequences disclosed in the format specified in option (iii), above, the amino acid sequence must be disclosed separately in the sequence listing as a pure amino acid sequence with a separate integer sequence identifier.

Nucleotide Sequences

Symbols to Be Used

8. A nucleotide sequence shall be presented only by a single strand, in the 5'-end to 3'-end direction from left to right. The terms 3' and 5' shall not be represented in the sequence.

9. The bases of a nucleotide sequence shall be represented using the one-letter code for nucleotide sequence characters. Only lower case letters in conformity with the list given in Appendix 2, Table 1, shall be used.

10. Modified bases shall be represented as the corresponding unmodified bases or as “n” in the sequence itself if the modified base is one of those listed in Appendix 2, Table 2, and the modification shall be further described in the feature section of the sequence listing, using the codes given in Appendix 2, Table 2. These codes may be used in the description or the feature section of the sequence listing but not in the sequence itself (see also paragraph 32). The symbol “n” is the equivalent of only one unknown or modified nucleotide.

Format to Be Used

11. A nucleotide sequence shall be listed with a maximum of 60 bases per line, with a space between each group of 10 bases.

12. The bases of a nucleotide sequence (including introns) shall be listed in groups of 10 bases, except in the coding parts of the sequence. Leftover bases, fewer than 10 in number at the end of non-coding parts of a sequence, should be grouped together and separated from adjacent groups by a space.

13. The bases of the coding parts of a nucleotide sequence shall be listed as triplets (codons).

14. The enumeration of the nucleotide shall start at the first base of the sequence with number 1. It shall be continuous through the whole sequence in the direction 5' to 3'. It shall be marked in the right margin, next to the line containing the one-letter codes for the bases, and giving the number of the last base of that line. The enumeration method for nucleotide sequences set forth above remains applicable to nucleotide sequences that are circular in configuration, with the exception that the designation of the first nucleotide of the sequence may be made at the option of the applicant.

15. A nucleotide sequence that is made up of one or more non-contiguous segments of a larger sequence or of segments from different sequences shall be numbered as a separate sequence, with a separate sequence identifier. A sequence with a gap or gaps shall be numbered as a plurality of separate sequences with separate sequence identifiers, with the number of separate sequences being equal in number to the number of continuous strings of sequence data.

Amino Acid Sequences

Symbols to Be Used

16. The amino acids in a protein or peptide sequence shall be listed in the amino to carboxy direction from left to right. The amino and carboxy groups shall not be represented in the sequence.

17. The amino acids shall be represented using the three-letter code with the first letter as a capital and shall conform to the list given in Appendix 2, Table 3. An amino acid sequence that contains a blank or internal terminator symbols (for example, "Ter" or "*" or ".") may not be represented as a single amino acid sequence, but shall be presented as separate amino acid sequences (see paragraph 22).

18. Modified and unusual amino acids shall be represented as the corresponding unmodified amino acids or as "Xaa" in the sequence itself if the modified amino acid is one of those listed in Appendix 2, Table 4, and the modification shall be further described in the feature section of the sequence listing, using the codes given in Appendix 2, Table 4. These codes may be used in the description or the feature section of the sequence listing but not in the sequence itself (see also paragraph 32). The symbol "Xaa" is the equivalent of only one unknown or modified amino acid.

Format to Be Used

19. A protein or peptide sequence shall be listed with a maximum of 16 amino acids per line, with a space provided between each amino acid.

20. Amino acids corresponding to the codons in the coding parts of a nucleotide sequence shall be placed immediately under the corresponding codons. Where a codon is split by an intron, the amino acid symbol should be given below the portion of the codon containing two nucleotides.

21. The enumeration of amino acids shall start at the first amino acid of the sequence, with number 1. Optionally, the amino acids preceding the mature protein, for example pre-sequences, pro-sequences, pre-pro-sequences and signal sequences, when present, may have negative numbers, counting backwards starting with the amino

ADMINISTRATIVE INSTRUCTIONS UNDER THE PCT

acid next to number 1. Zero (0) is not used when the numbering of amino acids uses negative numbers to distinguish the mature protein. It shall be marked under the sequence every five amino acids. The enumeration method for amino acid sequences set forth above remains applicable for amino acid sequences that are circular in configuration, with the exception that the designation of the first amino acid of the sequence may be made at the option of the applicant.

22. An amino acid sequence that is made up of one or more non-contiguous segments of a larger sequence or of segments from different sequences shall be numbered as a separate sequence, with a separate sequence identifier. A sequence with a gap or gaps shall be numbered as a plurality of separate sequences with separate sequence identifiers, with the number of separate sequences being equal in number to the number of continuous strings of sequence data.

Other Available Information in the Sequence Listing

23. The order of the items of information in the sequence listings shall follow the order in which those items are listed in the list of numeric identifiers of data elements as defined in Appendix 1.

24. Only numeric identifiers of data elements as defined in Appendix 1 shall be used for the presentation of the items of information in the sequence listing. The corresponding numeric identifier descriptions shall not be used. The provided information shall follow immediately after the numeric identifier while only those numeric identifiers for which information is given need appear on the sequence listing. Two exceptions to this requirement are numeric identifiers <220> and <300>, which serve as headers for "Feature" and "Publication Information," respectively, and are associated with information in numeric identifiers <221> to <223> and <301> to <313>, respectively. When feature and publication information is provided in the sequence listing under those numeric identifiers, numeric identifiers <220> and <300>, respectively, should be included, but left blank. Generally, a blank line shall be inserted between numeric identifiers when the digit in the first or second position of the numeric identifier changes. An exception to this general rule is that no blank line should appear preceding numeric identifier <310>. Additionally, a blank line shall precede any repeated numeric identifier.

Mandatory Data Elements

25. The sequence listing shall include, in addition to and immediately preceding the actual nucleotide and/or amino acid sequence, the following items of information defined in Appendix 1 (mandatory data elements).

<110>	Applicant name
<120>	Title of invention
<160>	Number of SEQ ID NOs
<210>	SEQ ID NO: x
<211>	Length
<212>	Type
<213>	Organism
<400>	Sequence

MANUAL OF PATENT EXAMINING PROCEDURE

Where the name of the applicant (numeric identifier <110>) is written in characters other than those of the Latin alphabet, it shall also be indicated in characters of the Latin alphabet either as a mere transliteration or through translation into English.

The data elements, except those under numeric identifiers <110>, <120> and <160>, shall be repeated for each sequence included in the sequence listing. Only the data elements under numeric identifiers <120> and <400> are mandatory if no sequence is present for a sequence identifier (see paragraph 5, above, and SEQ ID NO: 4 in the example depicted in Appendix 3 of this Standard).

26. In addition to the data elements identified in paragraph 25, above, when a sequence listing is filed at the same time as the application to which it pertains or at any time prior to the assignment of an application number, the following data element shall be included in the sequence listing.

<130>	File reference
-------	----------------

27. In addition to the data elements identified in paragraph 25, above, when a sequence listing is filed in response to a request from a competent Authority or at any time following the assignment of an application number, the following data elements shall be included in the sequence listing.

<140>	Current patent application
<141>	Current filing date

28. In addition to the data elements identified in paragraph 25, above, when a sequence listing is filed relating to an application which claims the priority of an earlier application, the following data elements shall be included in the sequence listing:

<150>	Earlier patent application
<151>	Earlier application filing date

29. If “n” or “Xaa” or a modified base or modified/unusual L-amino acid is used in the sequence, the following data elements are mandatory:

<220>	Feature
<221>	Name/key
<222>	Location
<223>	Other information

30. If the organism (numeric identifier <213>) is “Artificial Sequence” or “Unknown,” the following data elements are mandatory:

ADMINISTRATIVE INSTRUCTIONS UNDER THE PCT

<220>	Feature
<223>	Other information

Optional Data Elements

31. All data elements defined in Appendix 1, not mentioned in paragraphs 25 to 30, above, are optional (optional data elements).

Presentation of Features

32. When features of sequences are presented (that is, numeric identifier <220>), they shall be described by the “feature keys” set out in Appendix 2, Tables 5 and 6.⁶³

Free Text

33. “Free text” is a wording describing characteristics of the sequence under numeric identifier <223> (Other information) which does not use language-neutral vocabulary as referred to in paragraph 2(vii).

34. The use of free text shall be limited to a few short terms indispensable for the understanding of the sequence. It shall not exceed four lines with a maximum of 65 characters per line for each given data element, when written in English. Any further information shall be included in the main part of the description in the language thereof.

35. Any free text should preferably be in the English language.

36. Where the sequence listing part of the description contains free text, any such free text shall be repeated in the main part of the description in the language thereof. It is recommended that the free text in the language of the main part of the description be put in a specific section of the description called “Sequence Listing Free Text.”

Subsequently Furnished Sequence Listing

37. Any sequence listing which is not contained in the application as filed but which is furnished subsequently shall not go beyond the disclosure in the application as filed and shall be accompanied by a statement to that effect. This means that a sequence listing furnished subsequently to the filing of the application shall contain only those sequences that were disclosed in the application as filed.

38. Any sequence listing not contained in the application as filed does not form part of the application. However, the provisions of PCT Rules 13^{ter}, 26.3, and 91 and PCT Article 34 would apply, so that it may be possible, subject to the applicable provisions, for a sequence listing contained in the application as filed to be corrected under PCT Rules 13^{ter} or 26.3, rectified under PCT Rule 91 (in the case of an obvious error), or amended under PCT Article 34, or for a sequence listing to be submitted under PCT Article 34 as an amendment to the application.

Computer Readable Form of the Sequence Listing

39. A copy of the sequence listing shall also be submitted in computer readable form, in addition to the sequence listing as contained in the application, whenever this is required by the competent Authority.

⁶³*Editor's Note:* These tables contain extracts from the DDBJ/EMBL/GenBank Feature Table (nucleotide sequences) and the SWISS PROT Feature Table (amino acid sequences).

MANUAL OF PATENT EXAMINING PROCEDURE

40. Any sequence listing in computer readable form submitted in addition to the written sequence listing shall be identical to the written sequence listing and shall be accompanied by a statement that “the information recorded in computer readable form is identical to the written sequence listing.”

41. The entire printable copy of the sequence listing shall be contained within one electronic file preferably on a single diskette or any other electronic medium that is acceptable to the competent Authority. The file recorded on the diskette or any other electronic medium that is acceptable to the competent Authority shall be encoded using IBM⁶⁴ Code Page 437, IBM Code Page 932⁶⁵ or a compatible code page. A compatible code page, as would be required for, for example, Japanese, Chinese, Cyrillic, Arabic, Greek or Hebrew characters, is one that assigns the Roman alphabet and numerals to the same hexadecimal positions as do the specified code pages.

42. The computer readable form shall preferably be created by dedicated software such as PatentIn or other custom computer programs; it may be created by any means, as long as the sequence listing on a submitted diskette or any other electronic medium that is acceptable to the competent Authority is readable under a Personal Computer Operating system that is acceptable to the competent Authority.

43. File compression is acceptable when using diskette media, so long as the compressed file is in a self-extracting format that will decompress on a Personal Computer Operating system that is acceptable to the competent Authority.

44. The diskette or any other electronic medium that is acceptable to the competent Authority shall have a label permanently affixed thereto on which has been hand-printed, in block capitals or typed, the name of the applicant, the title of the invention, a reference number, the date on which the data were recorded, the computer operating system and the name of the competent Authority.

45. If the diskette or any other electronic medium that is acceptable to the competent Authority is submitted after the date of filing of an application, the labels shall also include the filing date of the application and the application number.

46. Any correction of the written sequence listing which is submitted under PCT Rules 13^{ter}.1(a)(i) or 26.3, any rectification of an obvious error in the written sequence listing which is submitted under PCT Rule 91, or any amendment which includes a written sequence listing and which is submitted under PCT Article 34, shall be accompanied by a computer readable form of the sequence listing including any such correction, rectification or amendment.

Appendices

Appendix 1: Numeric Identifiers

⁶⁴*Editor's Note:* IBM is a registered trademark of International Business Machine Corporation, United States of America.

⁶⁵*Editor's Note:* The specified code pages are de facto standards for personal computers.

ADMINISTRATIVE INSTRUCTIONS UNDER THE PCT

Appendix 2: Nucleotide and Amino Acid Symbols and Feature Table

Table 1:	List of Nucleotides
Table 2:	List of Modified Nucleotides
Table 3:	List of Amino Acids
Table 4:	List of Modified and Unusual Amino Acids
Table 5:	List of Feature Keys Related to Nucleotide Sequences
Table 6:	List of Feature Keys Related to Protein Sequences

Appendix 3: Specimen Sequence Listing

[Appendices 1 to 3 to Annex C follow]

**Annex C, Appendix 1
Numeric Identifiers**

Only numeric identifiers as defined below may be used in sequence listings submitted in applications. The text of the data element headings given below shall not be included in the sequence listings.

Numeric identifiers of mandatory data elements, that is, data elements which must be included in all sequence listings (see paragraph 25 of this Standard: items 110, 120, 160, 210, 211, 212, 213 and 400) and numeric identifiers of data elements which must be included in circumstances specified in this Standard (see paragraphs 26, 27, 28, 29 and 30 of this Standard: items 130, 140, 141, 150 and 151, and 220 to 223) are marked by the symbol “M.”

Numeric identifiers of optional data elements (see paragraph 31 of this Standard) are marked by the symbol “O.”

Numeric Identifier	Numeric Identifier Description	Mandatory (M) or Optional (O)	Comment
<110>	Applicant name	M	where the name of the applicant is written in characters other than those of the Latin alphabet, the same shall also be indicated in characters of the Latin alphabet either as a mere transliteration or through translation into English
<120>	Title of Invention	M	
<130>	File Reference	M, in the circumstances specified in paragraph 26 of this Standard	see paragraph 26 of this Standard
<140>	Current patent application	M, in the circumstances specified in paragraph 27 of this Standard	see paragraph 27 of this Standard; the current patent application shall be identified, in the following order, by the two-letter code indicated in accordance with WIPO Standard ST.3 and the application number (in the format used by the industrial property Office with which the current patent application is filed) or, for an international application, by the international application number
<141>	Current filing date	M, in the circumstances specified in paragraph 27 of this Standard	see paragraph 27 of this Standard; the date shall be indicated in accordance with WIPO Standard ST.2 (CCYY MM DD)

ADMINISTRATIVE INSTRUCTIONS UNDER THE PCT

Numeric Identifier	Numeric Identifier Description	Mandatory (M) or Optional (O)	Comment
<150>	Earlier patent application	M, in the circumstances specified in paragraph 28 of this Standard	see paragraph 28 of this Standard; the earlier patent application shall be identified, in the following order, by the two-letter code indicated in accordance with WIPO Standard ST.3 and the application number (in the format used by the industrial property Office with which the earlier patent application was filed) or, for an international application, by the international application number
<151>	Earlier application filing date	M, in the circumstances specified in paragraph 28 of this Standard	see paragraph 28 of this Standard; the date shall be indicated in accordance with WIPO Standard ST.2 (CCYY MM DD)
<160>	Number of SEQ ID NOs	M	
<170>	Software	O	
<210>	Information for SEQ ID NO: x	M	response shall be an integer representing the SEQ ID NO shown
<211>	Length	M	sequence length expressed in number of base pairs or amino acids
<212>	Type	M	type of molecule sequenced in SEQ ID NO: x, either DNA, RNA or PRT; if a nucleotide sequence contains both DNA and RNA fragments, the value shall be "DNA"; in addition, the combined DNA/RNA molecule shall be further described in the <220> to <223> feature section
<213>	Organism	M	Genus Species (that is, scientific name) or "Artificial Sequence" or "Unknown"
<220>	Feature	M, in the circumstances specified in paragraph 29 and 30 of this Standard	leave blank; see paragraphs 29 and 30 of this Standard; description of points of biological significance in the sequence in SEQ ID NO: x) (may be repeated depending on the number of features indicated)
<221>	Name/key	M in the circumstances specified in paragraph 29 of this Standard	see paragraph 29 of this Standard; only those keys as described in Table 5 or 6 of Appendix 2 shall be used
<222>	Location	M, in the circumstances specified in paragraph 29 of this Standard	see paragraph 29 of this Standard; - from (number of first base/amino acid in the feature) - to (number of last base/amino acid in the feature) - base pairs (numbers refer to positions of base pairs in a nucleotide sequence) - amino acids (numbers refer to positions of amino acid residues in an amino acid sequence) - whether feature is located on the complementary strand to that filed in the sequence listing

MANUAL OF PATENT EXAMINING PROCEDURE

Numeric Identifier	Numeric Identifier Description	Mandatory (M) or Optional (O)	Comment
<223>	Other information:	M, in the circumstances specified in paragraphs 29 and 30 of this Standard	see paragraphs 29 and 30 of this Standard; any other relevant information, using language neutral vocabulary, or free text (preferably in English); any free text is to be repeated in the main part of the description in the language thereof (see paragraph 36 of this Standard); where any modified base or modified/unusual L-amino acid appearing in Appendix 2, Tables 2 and 4, is in the sequence, the symbol associated with that base or amino acid from Appendix 2, Tables 2 and 4, should be used
<300>	Publication information	O	leave blank; repeat section for each relevant publication
<301>	Authors	O	
<302>	Title	O	title of publication
<303>	Journal	O	journal name in which data published
<304>	Volume	O	journal volume in which data published
<305>	Issue	O	journal issue number in which data published
<306>	Pages	O	journal page numbers on which data published
<307>	Date	O	journal date on which data published; if possible, the date shall be indicated in accordance with WIPO Standard ST.2 (CCYY MM DD)
<308>	Database accession number	O	accession number assigned by database including database name
<309>	Database entry date	O	date of entry in database; the date shall be indicated in accordance with WIPO Standard ST.2 (CCYY MM DD)
<310>	Document number	O	document number, for patent type citations only; the full document shall specify, in the following order, the two-letter code indicated in accordance with WIPO Standard ST.3, the publication number indicated in accordance with WIPO Standard ST.6, and the kind-of-document code indicated in accordance with WIPO Standard ST.16
<311>	Filing date	O	document filing date, for patent-type citations only; the date shall be indicated in accordance with WIPO Standard ST.2 (CCYY MM DD)

ADMINISTRATIVE INSTRUCTIONS UNDER THE PCT

Numeric Identifier	Numeric Identifier Description	Mandatory (M) or Optional (O)	Comment
<312>	Publication date	O	document publication date; for patent-type citations only; the date shall be indicated in accordance with WIPO Standard ST.2 (CCYY MM DD)
<313>	Relevant residues in SEQ ID NO: x: from to	O	
<400>	Sequence	M	SEQ ID NO: x should follow the numeric identifier and should appear on the line preceding the sequence (see Appendix 3)

Annex C, Appendix 2
Nucleotide and Amino Acid Symbols and Feature Table

Table 1: List of Nucleotides

Symbol	Meaning	Origin of designation
a	a	<u>a</u> denine
g	g	<u>g</u> uanine
c	c	<u>c</u> ytosine
t	t	<u>t</u> hymine
u	u	<u>u</u> racil
r	g or a	<u>p</u> urine
y	t/u or c	<u>p</u> yrimidine
m	a or c	<u>a</u> mino
k	g or t/u	<u>k</u> eto
s	g or c	<u>s</u> trong interactions 3H-bonds
w	a or t/u	<u>w</u> weak interactions 2H-bonds
b	g or c or t/u	not a
d	a or g or t/u	not c
h	a or c or t/u	not g
v	a or g or c	not t, not u
n	a or g or c or t/u, unknown, or other	<u>a</u> ny

Table 2: List of Modified Nucleotides

Symbol	Meaning
ac4c	4-acetylcytidine
chm5u	5-(carboxyhydroxymethyl)uridine
cm	2'-O-methylcytidine
cmnm5s2u	5-carboxymethylaminomethyl-2-thiouridine
cmnm5u	5-carboxymethylaminomethyluridine
d	dihydrouridine
fm	2'-O-methylpseudouridine
gal q	beta, D-galactosylqueuosine

ADMINISTRATIVE INSTRUCTIONS UNDER THE PCT

Symbol	Meaning
gm	2'-O-methylguanosine
i	inosine
i6a	N6-isopentenyladenosine
m1a	1-methyladenosine
m1f	1-methylpseudouridine
m1g	1-methylguanosine
m1i	1-methylinosine
m22g	2,2-dimethylguanosine
m2a	2-methyladenosine
m2g	2-methylguanosine
m3c	3-methylcytidine
m5c	5-methylcytidine
m6a	N6-methyladenosine
m7g	7-methylguanosine
mam5u	5-methylaminomethyluridine
mam5s2u	5-methoxyaminomethyl-2-thiouridine
man q	beta, D-mannosylqueuosine
mcm5s2u	5-methoxycarbonylmethyl-2-thiouridine
mcm5u	5-methoxycarbonylmethyluridine
mo5u	5-methoxyuridine
ms2i6a	2-methylthio-N6-isopentenyladenosine
ms2t6a	N-((9-beta-D-ribofuranosyl-2-methylthiopurine-6-yl)carbamoyl)threonine
mt6a	N-((9-beta-D-ribofuranosylpurine-6-yl)N-methylcarbamoyl)threonine
mv	uridine-5-oxyacetic acid-methylester
o5u	uridine-5-oxyacetic acid
osyw	wybutoxosine
p	pseudouridine
q	queuosine
s2c	2-thiocytidine
s2t	5-methyl-2-thiouridine

MANUAL OF PATENT EXAMINING PROCEDURE

Symbol	Meaning
s2u	2-thiouridine
s4u	4-thiouridine
t	5-methyluridine
t6a	N-((9-beta-D-ribofuranosylpurine-6-yl)-carbamoyl)threonine
tm	2'-O-methyl-5-methyluridine
um	2'-O-methyluridine
yw	wybutosine
x	3-(3-amino-3-carboxy-propyl)uridine, (acp3)u

Table 3: List of Amino Acids

Symbol	Meaning
Ala	Alanine
Cys	Cysteine
Asp	Aspartic Acid
Glu	Glutamic Acid
Phe	Phenylalanine
Gly	Glycine
His	Histidine
Ile	Isoleucine
Lys	Lysine
Leu	Leucine
Met	Methionine
Asn	Asparagine
Pro	Proline
Gln	Glutamine
Arg	Arginine
Ser	Serine
Thr	Threonine
Val	Valine
Trp	Tryptophan

ADMINISTRATIVE INSTRUCTIONS UNDER THE PCT

Symbol	Meaning
Tyr	Tyrosine
Asx	Asp or Asn
Glx	Glu or Gln
Xaa	unknown or other

Table 4: List of Modified and Unusual Amino Acids

Symbol	Meaning
Aad	2-Aminoadipic acid
bAad	3-Aminoadipic acid
bAla	beta-Alanine, beta-Aminopropionic acid
Abu	2-Aminobutyric acid
4Abu	4-Aminobutyric acid, piperidinic acid
Acp	6-Aminocaproic acid
Ahe	2-Aminoheptanoic acid
Aib	2-Aminoisobutyric acid
bAib	3-Aminoisobutyric acid
Apm	2-Aminopimelic acid
Dbu	2,4 Diaminobutyric acid
Des	Desmosine
Dpm	2,2'-Diaminopimelic acid
Dpr	2,3-Diaminopropionic acid
EtGly	N-Ethylglycine
EtAsn	N-Ethylasparagine
Hyl	Hydroxylysine
aHyl	allo-Hydroxylysine
3Hyp	3-Hydroxyproline
4Hyp	4-Hydroxyproline
Ide	Isodesmosine
alle	allo-Isoleucine
MeGly	N-Methylglycine, sarcosine

MANUAL OF PATENT EXAMINING PROCEDURE

Symbol	Meaning
Melle	N-Methylisoleucine
MeLys	6-N-Methyllysine
MeVal	N-Methylvaline
Nva	Norvaline
Nle	Norleucine
Orn	Ornithine

Table 5: List of Feature Keys Related to Nucleotide Sequences

Key	Description
allele	a related individual or strain contains stable, alternative forms of the same gene which differs from the presented sequence at this location (and perhaps others)
attenuator	(1) region of DNA at which regulation of termination of transcription occurs, which controls the expression of some bacterial operons; (2) sequence segment located between the promoter and the first structural gene that causes partial termination of transcription
C_region	constant region of immunoglobulin light and heavy chains, and T-cell receptor alpha, beta, and gamma chains; includes one or more exons depending on the particular chain
CAAT_signal	CAAT box; part of a conserved sequence located about 75 bp up-stream of the start point of eukaryotic transcription units which may be involved in RNA polymerase binding; consensus=GG (C or T) CAATCT
CDS	coding sequence; sequence of nucleotides that corresponds with the sequence of amino acids in a protein (location includes stop codon); feature includes amino acid conceptual translation
conflict	independent determinations of the “same” sequence differ at this site or region
D-loop	displacement loop; a region within mitochondrial DNA in which a short stretch of RNA is paired with one strand of DNA, displacing the original partner DNA strand in this region; also used to describe the displacement of a region of one strand of duplex DNA by a single stranded invader in the reaction catalyzed by RecA protein
D-segment	diversity segment of immunoglobulin heavy chain, and T-cell receptor beta chain
enhancer	a cis-acting sequence that increases the utilization of (some) eukaryotic promoters, and can function in either orientation and in any location (upstream or downstream) relative to the promoter
exon	region of genome that codes for portion of spliced mRNA; may contain 5'UTR all CDSs, and 3'UTR
GC_signal	GC box; a conserved GC-rich region located upstream of the start point of eukaryotic transcription units which may occur in multiple copies or in either orientation; consensus=GGGCGG

ADMINISTRATIVE INSTRUCTIONS UNDER THE PCT

Key	Description
gene	region of biological interest identified as a gene and for which a name has been assigned
iDNA	intervening DNA; DNA which is eliminated through any of several kinds of recombination
intron	a segment of DNA that is transcribed, but removed from within the transcript by splicing together the sequences (exons) on either side of it
J_segment	joining segment of immunoglobulin light and heavy chains, and T-cell receptor alpha, beta, and gamma chains
LTR	long terminal repeat, a sequence directly repeated at both ends of a defined sequence, of the sort typically found in retroviruses
mat_peptide	mature peptide or protein coding sequence; coding sequence for the mature or final peptide or protein product following post-translational modification; the location does not include the stop codon (unlike the corresponding CDS)
misc_binding	site in nucleic acid which covalently or non-covalently binds another moiety that cannot be described by any other Binding key (primer_bind or protein_bind)
misc_difference	feature sequence is different from that presented in the entry and cannot be described by any other Difference key (conflict, unsure, old_sequence, mutation, variation, allele, or modified_base)
misc_feature	region of biological interest which cannot be described by any other feature key; a new or rare feature
misc_recomb	site of any generalized, site-specific or replicative recombination event where there is a breakage and reunion of duplex DNA that cannot be described by other recombination keys (iDNA and virion) or qualifiers of source key (/insertion_seq, /transposon, /proviral)
misc_RNA	any transcript or RNA product that cannot be defined by other RNA keys (prim_transcript, precursor_RNA, mRNA, 5' clip, 3' clip, 5'UTR, 3'UTR, exon, CDS, sig_peptide, transit_peptide, mat_peptide, intron, polyA_site, rRNA, tRNA, scRNA, and snRNA)
misc_signal	any region containing a signal controlling or altering gene function or expression that cannot be described by other Signal keys (promoter, CAAT_signal, TATA_signal, -35_signal, -10_signal, GC_signal, RBS, polyA_signal, enhancer, attenuator, terminator, and rep_origin)
misc_structure	any secondary or tertiary structure or conformation that cannot be described by other Structure keys (stem_loop and D-loop)
modified_base	the indicated nucleotide is a modified nucleotide and should be substituted for by the indicated molecule (given in the mod_base qualifier value)
mRNA	messenger RNA; includes 5' untranslated region (5'UTR), coding sequences (CDS, exon) and 3' untranslated region (3'UTR)
mutation	a related strain has an abrupt, inheritable change in the sequence at this location

MANUAL OF PATENT EXAMINING PROCEDURE

Key	Description
N_region	extra nucleotides inserted between rearranged immunoglobulin segments
old_sequence	the presented sequence revises a previous version of the sequence at this location
polyA_signal	recognition region necessary for endonuclease cleavage of an RNA transcript that is followed by polyadenylation; consensus=AATAAA
polyA_site	site on an RNA transcript to which will be added adenine residues by post-transcriptional polyadenylation
precursor_RNA	any RNA species that is not yet the mature RNA product; may include 5' clipped region (5' clip), 5' untranslated region (5'UTR), coding sequences (CDS, exon), intervening sequences (intron), 3' untranslated region (3'UTR), and 3' clipped region (3'clip)
prim_transcript	primary (initial, unprocessed) transcript; includes 5' (5'clip), 5' untranslated region (5'UTR), coding sequences (CDS, exon), intervening sequences (intron), 3' untranslated region (3'UTR), and 3' clipped region (3' clip)
primer_bind	non-covalent primer binding site for initiation of replication, transcription, or reverse transcription; includes site(s) for synthetic, for example, PCR primer elements
promoter	region on a DNA molecule involved in RNA polymerase binding to initiate transcription
protein_bind	non-covalent protein binding site on nucleic acid
RBS	ribosome binding site
repeat_region	region of genome containing repeating units
repeat_unit	single repeat element
rep_origin	origin of replication; starting site for duplication of nucleic acid to give two identical copies
rRNA	mature ribosomal RNA; the RNA component of the ribonucleoprotein particle (ribosome) which assembles amino acids into proteins
S_region	switch region of immunoglobulin heavy chains; involved in the rearrangement of heavy chain DNA leading to the expression of a different immunoglobulin class from the same B-cell
satellite	many tandem repeats (identical or related) of a short basic repeating unit; many have a base composition or other property different from the genome average that allows them to be separated from the bulk (main band) genomic DNA
scRNA	small cytoplasmic RNA; any one of several small cytoplasmic RNA molecules present in the cytoplasm and (sometimes) nucleus of a eukaryote
sig_peptide	signal peptide coding sequence; coding sequence for an N-terminal domain of a secreted protein; this domain is involved in attaching nascent polypeptide to the membrane; leader sequence
snRNA	small nuclear RNA; any one of many small RNA species confined to the nucleus; several of the snRNAs are involved in splicing or other RNA processing reactions

ADMINISTRATIVE INSTRUCTIONS UNDER THE PCT

Key	Description
source	identifies the biological source of the specified span of the sequence; this key is mandatory; every entry will have, as a minimum, a single source key spanning the entire sequence; more than one source key per sequence is permissible
stem_loop	hairpin; a double-helical region formed by base-pairing between adjacent (inverted) complementary sequences in a single strand of RNA or DNA
STS	Sequence Tagged Site; short, single-copy DNA sequence that characterizes a mapping landmark on the genome and can be detected by PCR; a region of the genome can be mapped by determining the order of a series of STSs
TATA_signal	TATA box; Goldberg-Hogness box; a conserved AT-rich septamer found about 25 bp before the start point of each eukaryotic RNA polymerase II transcript unit which may be involved in positioning the enzyme for correct initiation; consensus=TATA(A or T)A(A or T)
terminator	sequence of DNA located either at the end of the transcript or adjacent to a promoter region that causes RNA polymerase to terminate transcription; may also be site of binding of repressor protein
transit_peptide	transit peptide coding sequence; coding sequence for an N-terminal domain of a nuclear-encoded organellar protein; this domain is involved in post-translational import of the protein into the organelle
tRNA	mature transfer RNA, a small RNA molecule (75-85 bases long) that mediates the translation of a nucleic acid sequence into an amino acid sequence
unsure	author is unsure of exact sequence in this region
V_region	variable region of immunoglobulin light and heavy chains, and T-cell receptor alpha, beta, and gamma chains; codes for the variable amino terminal portion; can be made up from V_segments, D_segments, N_regions, and J_segments
V_segment	variable segment of immunoglobulin light and heavy chains, and T-cell receptor alpha, beta, and gamma chains; codes for most of the variable region (V_region) and the last few amino acids of the leader peptide
variation	a related strain contains stable mutations from the same gene (for example, RFLPs, polymorphisms, etc.) which differ from the presented sequence at this location (and possibly others)
3'clip	3'-most region of a precursor transcript that is clipped off during processing
3'UTR	region at the 3' end of a mature transcript (following the stop codon) that is not translated into a protein
5'clip	5'-most region of a precursor transcript that is clipped off during processing
5'UTR	region at the 5' end of a mature transcript (preceding the initiation codon) that is not translated into a protein
-10_signal	pribnow box; a conserved region about 10 bp upstream of the start point of bacterial transcription units which may be involved in binding RNA polymerase; consensus=TAtAaT

MANUAL OF PATENT EXAMINING PROCEDURE

Key	Description
-35_signal	a conserved hexamer about 35 bp upstream of the start point of bacterial transcription units; consensus=TTGACa [] or TGTTGACA []

Table 6: List of Feature Keys Related to Protein Sequences

Key	Description
CONFLICT	different papers report differing sequences
VARIANT	authors report that sequence variants exist
VARSPLIC	description of sequence variants produced by alternative splicing
MUTAGEN	site which has been experimentally altered
MOD_RES	post-translational modification of a residue
ACETYLATION	N-terminal or other
AMIDATION	generally at the C-terminal of a mature active peptide
BLOCKED	undetermined N- or C-terminal blocking group
FORMYLATION	of the N-terminal methionine
GAMMA-CARBOXYGLUTAMIC ACID HYDROXYLATION	of asparagine, aspartic acid, proline or lysine
METHYLATION	generally of lysine or arginine
PHOSPHORYLATION	of serine, threonine, tyrosine, aspartic acid or histidine
PYRROLIDONE CARBOXYLIC ACID	N-terminal glutamate which has formed an internal cyclic lactam
SULFATATION	generally of tyrosine
LIPID	covalent binding of a lipidic moiety
MYRISTATE	myristate group attached through an amide bond to the N-terminal glycine residue of the mature form of a protein or to an internal lysine residue
PALMITATE	palmitate group attached through a thioether bond to a cysteine residue or through an ester bond to a serine or threonine residue
FARNESYL	farnesyl group attached through a thioether bond to a cysteine residue
GERANYL-GERANYL	geranyl-geranyl group attached through a thioether bond to a cysteine residue

ADMINISTRATIVE INSTRUCTIONS UNDER THE PCT

Key	Description
GPI-ANCHOR	glycosyl-phosphatidylinositol (GPI) group linked to the alpha-carboxyl group of the C-terminal residue of the mature form of a protein
N-ACYL DIGLYCERIDE	N-terminal cysteine of the mature form of a prokaryotic lipoprotein with an amide-linked fatty acid and a glyceryl group to which two fatty acids are linked by ester linkages
DISULFID	disulfide bond; the 'FROM' and 'TO' endpoints represent the two residues which are linked by an intra-chain disulfide bond; if the 'FROM' and 'TO' endpoints are identical, the disulfide bond is an interchain one and the description field indicates the nature of the cross-link
THIOLEST	thiolester bond; the 'FROM' and 'TO' endpoints represent the two residues which are linked by the thiolester bond
THIOETH	thioether bond; the 'FROM' and 'TO' endpoints represent the two residues which are linked by the thioether bond
CARBOHYD	glycosylation site; the nature of the carbohydrate (if known) is given in the description field
METAL	binding site for a metal ion; the description field indicates the nature of the metal
BINDING	binding site for any chemical group (co-enzyme, prosthetic group, etc.); the chemical nature of the group is given in the description field
SIGNAL	extent of a signal sequence (prepeptide)
TRANSIT	extent of a transit peptide (mitochondrial, chloroplastic, or for a microbody)
PROPEP	extent of a propeptide
CHAIN	extent of a polypeptide chain in the mature protein
PEPTIDE	extent of a released active peptide
DOMAIN	extent of a domain of interest on the sequence; the nature of that domain is given in the description field
CA_BIND	extent of a calcium-binding region
DNA_BIND	extent of a DNA-binding region
NP_BIND	extent of a nucleotide phosphate binding region; the nature of the nucleotide phosphate is indicated in the description field
TRANSMEM	extent of a transmembrane region
ZN_FING	extent of a zinc finger region

MANUAL OF PATENT EXAMINING PROCEDURE

Key	Description
SIMILAR	extent of a similarity with another protein sequence; precise information, relative to that sequence is given in the description field
REPEAT	extent of an internal sequence repetition
HELIX	secondary structure: Helices, for example, Alpha-helix, 3(10) helix, or Pi-helix
STRAND	secondary structure: Beta-strand, for example, Hydrogen bonded beta-strand, or Residue in an isolated beta-bridge
TURN	secondary structure Turns, for example, H-bonded turn (3-turn, 4-turn or 5-turn)
ACT_SITE	amino acid(s) involved in the activity of an enzyme
SITE	any other interesting site on the sequence
INIT_MET	the sequence is known to start with an initiator methionine
NON_TER	the residue at an extremity of the sequence is not the terminal residue; if applied to position 1, this signifies that the first position is not the N-terminus of the complete molecule; if applied to the last position, it signifies that this position is not the C-terminus of the complete molecule; there is no description field for this key
NON_CONS	non consecutive residues; indicates that two residues in a sequence are not consecutive and that there are a number of unsequenced residues between them
UNSURE	uncertainties in the sequence; used to describe region(s) of a sequence for which the authors are unsure about the sequence assignment

ADMINISTRATIVE INSTRUCTIONS UNDER THE PCT

**Annex C, Appendix 3
Specimen Sequence Listing**

```

<110> Smith, John; Smithgene Inc.
<120> Example of a Sequence Listing
<130> 01-00001
<140> PCT/EP98/00001
<141> 1998-12-31
<150> US 08/999,999
<151> 1997-10-15
<160> 4
<170> PatentIn version 2.0
<210> 1
<211> 389
<212> DNA
<213> Paramecium sp.
<220>
<221> CDS
<222> (279)...(389)
<300>
<301> Doe, Richard
<302> Isolation and Characterization of a Gene Encoding a
Protease from Paramecium sp.
<303> Journal of Genes
<304> 1
<305> 4
<306> 1-7
<307> 1988-06-31
<308> 123456
<309> 1988-06-31
<400> 1
agctgtagtc attcctgtgt cctctttctct ctgggcttct caccctgcta atcagatctc 60
agggagagtg tcttgaccct cctctgcctt tgcagcttca caggcaggca ggcaggcagc 120
tgatgtggca attgctggca gtgccacagg cttttcagcc aggcttaggg tgggttccgc 180
cgcggcgcgg cgcccctct cgcgctctc tcgcgctct ctctcgtct cctctcgtc 240
ggacctgatt aggtgagcag gaggaggggg cagttagc atg gtt tca atg ttc agc 296
                                     Met Val Ser Met Phe Ser
                                     1 5
ttg tct ttc aaa tgg cct gga ttt tgt ttg ttt gtt tgt ttg ttc caa 344
Leu Ser Phe Lys Trp Pro Gly Phe Cys Leu Phe Val Cys Leu Phe Gln
                                     10 15 20
tgt ccc aaa gtc ctc ccc tgt cac tca tca ctg cag ccg aat ctt 389
Cys Pro Lys Val Leu Pro Cys His Ser Ser Leu Gln Pro Asn Leu
                                     25 30 35

<210> 2
<211> 37
<212> PRT
<213> Paramecium sp.

```

MANUAL OF PATENT EXAMINING PROCEDURE

```
<400> 2
Met Val Ser Met Phe Ser Leu Ser Phe Lys Trp Pro Gly Phe Cys Leu
1          5          10          15
Phe Val Cys Leu Phe Gln Cys Pro Lys Val Leu Pro Cys His Ser Ser
          20          25          30
Leu Gln Pro Asn Leu
          35
<210> 3
<211> 11
<212> PRT
<213> Artificial Sequence
<220>
<223> Designed peptide based on size and polarity to act as a
linker between the alpha and beta chains of Protein XYZ.
<400> 3
Met Val Asn Leu Glu Pro Met His Thr Glu Ile
1          5          10
<210> 4
<400> 4
000
```

[Annex C-*bis* follows]

ANNEX C-bis

**TECHNICAL REQUIREMENTS FOR THE PRESENTATION OF TABLES
RELATED TO NUCLEOTIDE AND AMINO ACID SEQUENCE LISTINGS IN
INTERNATIONAL PATENT APPLICATIONS UNDER THE PCT**

Introduction

1. These technical requirements have been elaborated so as to provide standardization of the presentation of tables related to nucleotide and amino acid sequence listings in international patent applications. These technical requirements are intended to allow the applicant to draw up such tables in a manner which is acceptable to all receiving Offices, International Searching Authorities, International Preliminary Examining Authorities and to the International Bureau for the purposes of the international phase and to all designated and elected Offices for the purposes of the national phase.

Definition

2. For the purposes of these technical requirements, “competent Authority” is the International Searching Authority that is to carry out the international search on the international application, or the International Preliminary Examining Authority that is to carry out the international preliminary examination on the international application, or the designated/elected Office before which the processing of the international application has started.

Tables related to sequence listings

3. Tables filed in computer readable form under Section 801(a) shall comply with one of the following character formats:
 - (i) UTF-8-encoded Unicode 3.0; or
 - (ii) XML format conforming to the “Application-Body” Document Type Definition referred to in Appendix I of Annex F;

at the option of the competent Authority.

4. The spatial relationships (e.g., columns and rows) of the table elements shall be maintained.
5. At the option of the competent Authority, file compression is acceptable, so long as the compressed file is in a self-extracting format that will decompress on a Personal Computer Operating system that is acceptable to the competent Authority and to the International Bureau.
6. Each table shall be contained within a separate electronic file on any electronic medium that is acceptable to the competent Authority. The file recorded on the electronic medium that is acceptable to the competent Authority shall be encoded using IBM Code Page 437, IBM Code Page 932 or a compatible code page. A compatible code page, as would be required for, for example, Japanese, Chinese, Cyrillic, Arabic, Greek or Hebrew characters, is one that assigns the Roman alphabet and numerals to the same hexadecimal positions as do the specified code pages.
7. Tables filed in computer readable form may be created by any means, as long as the table on an electronic medium that is acceptable to the competent Authority is readable under a Personal Computer Operating system that is acceptable to the competent Authority and to the International Bureau.
8. If the electronic medium that is acceptable to the competent Authority is submitted after the date of filing of an application, the labels shall also include the filing date of the application and the application number.

[Annex D follows]

ANNEX D

**INFORMATION FROM PAMPHLET FRONT PAGE TO BE INCLUDED IN THE
GAZETTE UNDER RULE 86.1(a)(i)**

The following information shall be extracted from the front page of the pamphlet of each published international application and shall, in accordance with Rule 86.1(a)(i), appear in the corresponding entry of the Gazette:

1. as to the international publication:
 - 1.1 the international publication number
 - 1.2 the date of the international publication
 - 1.3 an indication whether the following items were published in the pamphlet:
 - 1.31 international search report
 - 1.32 declaration under Article 17(2)
 - 1.33 claims amended under Article 19(1)
 - 1.34 statement under Article 19(1)
 - 1.35 [*Deleted*]
 - 1.36 request for rectification under the third sentence of Rule 91.1(f)
 - 1.37 information concerning a priority claim which was considered not to have been made, published upon request made under Rule 26^{bis}.2(c)
 - 1.4 the language in which the international application was filed
 - 1.5 the language of publication of the international application
2. as to the international application:
 - 2.1 the title of the invention
 - 2.2 the symbol(s) of the International Patent Classification (IPC)
 - 2.3 the international application number
 - 2.4 the international filing date
3. as to any priority claim:
 - 3.1 the application number of the earlier application
 - 3.2 the date on which the earlier application was filed
 - 3.3 where the earlier application is:
 - 3.31 a national application: the country in which the earlier application was filed
 - 3.32 a regional application: the authority entrusted with the granting of regional patents under the applicable regional patent treaty and, in the case referred to in Rule 4.1 0(b)(ii), a country party to the Paris Convention for the Protection of Industrial Property for which that earlier application was filed
 - 3.33 an international application: the receiving Office with which it was filed
4. as to the applicant, inventor and agent:
 - 4.1 their name(s)
 - 4.2 their mailing address(es)
5. as to the designated States:
 - 5.1 their names
 - 5.2 the indication of any wish for a regional patent
 - 5.3 the indication that every kind of protection available is sought, unless otherwise indicated
6. as to a statement concerning non-prejudicial disclosure or exception to lack of novelty:

ADMINISTRATIVE INSTRUCTIONS UNDER THE PCT

- 6.1 the date of the disclosure
 - 6.2 the place of the disclosure
 - 6.3 the kind of the disclosure (e.g., exhibition, scientific publication, conference reports, etc.)
 - 6.4 the title of the exhibition, publication or conference
7. as to any indication in relation to deposited biological material furnished under Rule 13^{bis} separately from the description:
 - 7.1 the fact that such indication is published
 - 7.2 the date on which the International Bureau received such indication
 8. as to any declaration referred to in Rule 4.17 which was received by the International Bureau before the expiration of the time limit under Rule 26^{ter}.1:
 - 8.1 the fact that such a declaration was made and a reference to the applicable item in Rule 4.17 under which it was made
 - 8.2 an indication of those designations for the purposes of which such declaration was made.

[Annex E follows]

ANNEX E

INFORMATION TO BE PUBLISHED IN THE GAZETTE UNDER RULE 86.1(a)(v)

1. The time limits applicable under Articles 22 and 39 in respect of each Contracting State.
2. The list of the non-patent literature agreed upon by the International Searching Authorities for inclusion in the minimum documentation.
3. The names of the national Offices which do not wish to receive copies under Article 13(2)(c).
4. The provisions of the national laws of Contracting States concerning international-type search.
5. The text of the agreements entered into between the International Bureau and the International Searching Authorities or the International Preliminary Examining Authorities.
6. The names of the national Offices which entirely or in part waived their rights to any communication under Article 20.
7. The names of the Contracting States which are bound by Chapter II of the PCT.
8. Index of concordance of international application numbers and international publication numbers, listed according to international application numbers.
9. Index of applicants' names giving, for each name, the corresponding international publication number(s).
10. Index of international publication numbers, grouped according to the International Patent Classification symbols.
11. Indication of any subject matter that will not be searched or examined by the various International Searching and Preliminary Examining Authorities under Rules 39 and 67.
12. Requirements of designated and elected Offices under Rules 49.5 and 76.5 in relation to the furnishing of translations.
13. The dates defining the period referred to in Rule 32.1(b) during which the international application, whose effects may be extended to a successor State under Rule 32.1, must have been filed.

[Annex F follows]

ANNEX F

**STANDARD FOR THE ELECTRONIC FILING AND PROCESSING OF
INTERNATIONAL APPLICATIONS**

[The text of Annex F, which is not reproduced here, is available from WIPO's website at <http://www.wipo.org/pct/en/index.html>. To view Annex F, click on "PCT Gazette" and see PCT Gazette Special Issue S-04/2001 (27 December 2001). To see the complete text of the Administrative Instructions under the PCT, click on "PCT Legal Texts." Annex F consists of nine main sections and four appendices, the titles of which are reproduced below.]

1. *Introduction*
2. *The E-PCT standard: Overview and vision*
3. *E-PCT submission structure and format*
4. *IA documents packaging*
5. *Transmission*
6. *Electronic filing software*
7. *PCT workflow transactions*
8. *Principles of electronic records management*
9. *Abbreviated expressions, interpretation and glossary*

Appendix I XML DTDs for the E-PCT Standard

Appendix II PKI Architecture for the E-PCT Standard

Appendix III Basic Common Standard for Electronic Filing

Appendix IV Use of Physical Media for the E-PCT Standard]

[End of Appendix, Annex and document]

MANUAL OF PATENT EXAMINING PROCEDURE